

A111C25

printed on: 25-12-2023



TECHNICAL INFO

Media type	IMPREGNATED PAPER
Efficiency	25 $\mu\text{m}_{(c)}$ $\beta_x \geq 2$
Max working pressure	12 bar
Seals	NBR
Temperature range	-30°C +100°C

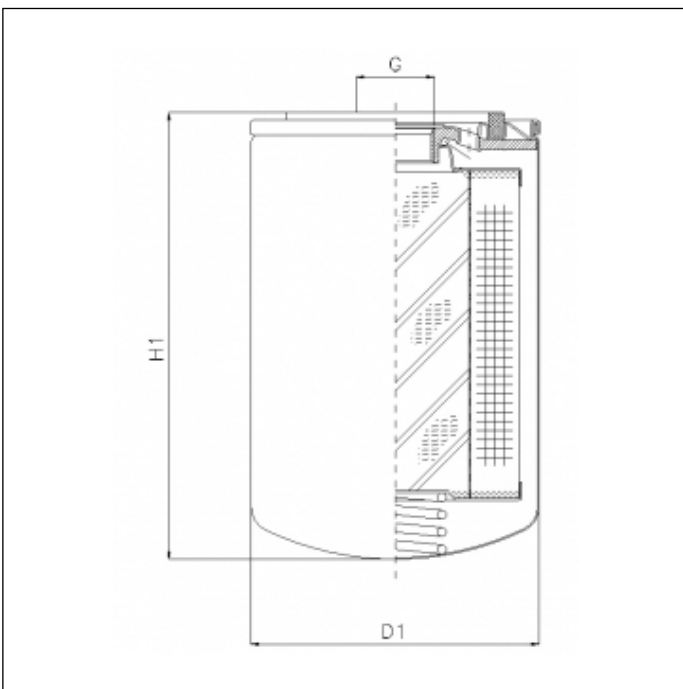

OVERALL DIMENSIONS

D1	96,0 mm
H1	213,0 mm
G	G 3/4

Technical information may change without notice. Image and drawing are representative only