

A120G06

printed on: 21-09-2023



TECHNICAL INFO

Media type	INORGANIC FIBERGLASS
Efficiency	5 $\mu\text{m}_{(c)}$ $\beta_x \geq 200$
Efficiency 1	7 $\mu\text{m}_{(c)}$ $\beta_x \geq 1000$
Max working pressure	12 bar
Seals	NBR
Temperature range	-30°C +100°C

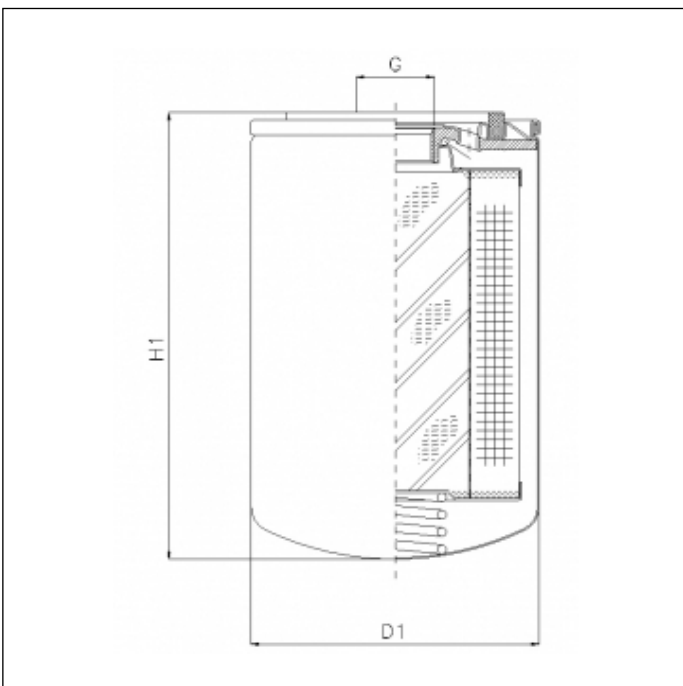

OVERALL DIMENSIONS

D1	129,0 mm
H1	182,0 mm
G	G 1 1/4

Technical information may change without notice. Image and drawing are representative only