

ADC.3... DIRECTIONAL CONTROL VALVES CETOP 3

SOLENOID OPERATED WITH REDUCED OVERALL SIZE

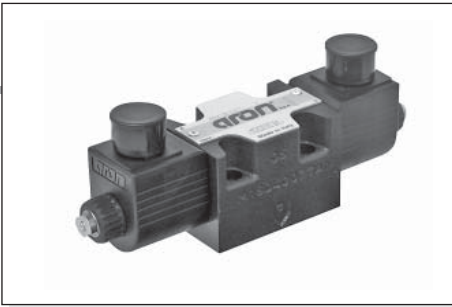

1



ADC.3.E...

"A09" DC COILS	CH. I PAGE 7
STANDARD CONNECTORS	CH. I PAGE 19

The ARON NG6 directional control valves are designed for subplate mounting with an interface in accordance with UNI ISO 4401 - 03 - 02 - 0 - 94 standard (ex CETOP R 35 H 4.2-4-03).

The use of solenoids with wet armatures allows an extremely safe construction completely dispensing with the need for dynamic seal. The solenoid tube is screwed directly onto the valve casting whilst the coil is kept in position by a ring nut.

The operation of the directional valve is electrical. The centring is achieved by means of calibrated length springs which, once the impulse is over, immediately reposition the spool in the neutral position. To improve the valve performance, different springs are used for each spool.

The solenoids, constructed with a protection class of IP65 in accordance with BS 5490 standards, are available in direct current form and different voltage. The electrical controls are equipped with an emergency manual control inserted in the tube.

The ADC.3 valve uses shorter solenoids than the standard AD.3.E to reduce the overall dimensions.

The solenoid coils are normally arranged for DIN 43650 ISO 4400 type connectors (standard version). On request, could be available the following coil connection variants: AMP Junior connections; flying leads connections, with or without integrated diode; Deutsch connections with bidirectional integrated diode.

The recommended fluids are hydraulic mineral based oils in accordance with DIN 51524 and it is recommended that filters should be fitted to ensure a maximum contamination level of class 10 in accordance with NAS 1638, $\beta_{25} \geq 75$.

Max. pressure ports P/A/B/T	250 bar
Max flow	30 l/min
Max excitation frequency	3 Hz
Duty cycle	100% ED
Fluid viscosity	10 ÷ 500 mm ² /s
Fluid temperature	-25°C ÷ 75°C
Ambient temperature	-25°C ÷ 60°C
Max contamination level	class 10 in accordance with NAS 1638 with filter $\beta_{25} \geq 75$
Weight with one DC solenoid	1,25 Kg
Weight with two DC solenoids	1,5 Kg

PRESSURE DROPS

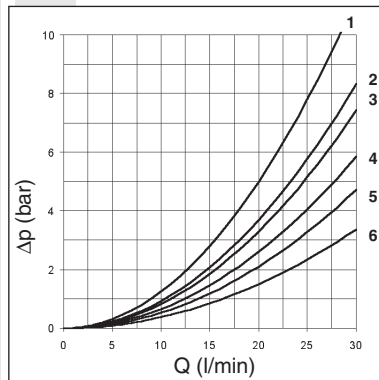

Spool type	Connections				
	P→A	P→B	A→T	B→T	P→T
01	4	4	4	4	
02	6	6	6	6	6
03	4	4	6	6	
04	3	3	2	2	5
15E-16E	6	3	1	5	
15F-16F	3	6	5	1	

Curve No.

The diagram at the side shows the pressure drop curves for spools during normal usage. The fluid used is a mineral oil with a viscosity of 46 mm²/s at 40 C°; the tests have been carried out at a fluid temperature of 40 C°. For higher flow rates than those in the diagram, the losses will be those expressed by the following formula:

$$\Delta p_1 = \Delta p \times (Q_1/Q)^2$$

where Δp will be the value for the losses for a specific flow rate Q which can be obtained from the diagram, Δp_1 will be the value of the losses for the flow rate Q₁ that is used.

1

ORDERING CODE

ADC	Directional valve
3	CETOP 3/NG6
E	Electrical operator
**	Spool (tables at the side)
*	Mounting (table 1)
*	Voltage (table 2)
**	Variants (table 3)
1	Serial No.

TAB.1 - MOUNTING

STANDARD	
C	
E	
F	
SPECIALS (WITH PRICE INCREASING)	
G	
H	

STANDARD SPOOL

* SPOOLS WITH PRICE INCREASING

TWO SOLENOIDS, SPRING CENTRED "C" MOUNTING			
Spool type		Covering	Transient position
01		+	
02		-	
03		+	
04*		-	

ONE SOLENOID, SIDE A "E" MOUNTING

Spool type		Covering	Transient position
01		+	
02		-	
03		+	
04*		-	
15		-	
16		+	

ONE SOLENOID, SIDE B "F" MOUNTING

Spool type		Covering	Transient position
01		+	
02		-	
03		+	
04*		-	
15		-	
16		+	

TAB.2 - A09 (27 W) COIL

DC VOLTAGE **	
L	12V
M	24V
N	48V*
P	110V*
Z	102V*
X	205V*
W	Without DC coils

115Vac/50Hz
120Vac/60Hz
with rectifier

230Vac/50Hz
240Vac/60Hz
with rectifier

Voltage codes are not stamped on the plate, they are readable on the coils.

* Special voltage

** Technical data see page I • 7

TAB.3 - VARIANTS

No variant (without connectors)	S1(*)
Viton	SV(*)
Emergency button	ES(*)
Rotary emergency button	P2 (*)(**)
Rotary emergency button (180°)	R5 (*)(**)
Variant with lever for emergency button	LF(*)
AMP Junior connection	AJ(*)
Coil with flying leads (250 mm)	FL
Coil with flying leads (130 mm) with diode	LD
Deutsch connection with bidirectional diode	CX

Other variants available on request.

(*) Coils with Hirschmann and AMP Junior connection supplied without connectors. The connectors can be ordered separately, ch. I page 19.

(**) P2 and R5 Emergency tightening torque max. 6÷9 Nm / 0.6 ÷ 0.9 Kgm with CH n. 22

• The AMP Junior coil and with the flying leads (with or without diode) coils are available in 12V or 24V DC voltage only.

• The Deutsch coil with bidirectional diode is available in 12V DC voltage only.

LIMITS OF USE (MOUNTING C-E-F)

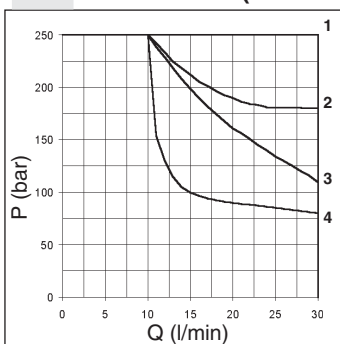

Spool type	n° curve
01	2
02	1
03	3
04	3
15	4
16	1(4*)

(4*) = 16 spools used for 3 way valve, follow the curve n°4

The tests have been carried out with solenoids operating temperature and a voltage 10% less than rated voltage with a fluid temperature of 50 C°. The fluid used was a mineral oil with a viscosity of 46 mm²/s at 40 degrees C. The values in the diagram refer to tests carried out with the oil flow in two directions simultaneously (e.g. from P to A and at the same time B to T).

In the cases where valves 4/2 and 4/3 are used with the flow in one direction only, the limits of use could have variations which may even be negative (See curve No 4 and Spool No 16). The tests were carried out with a counter-pressure of 2 bar at T port.

OVERALL DIMENSIONS

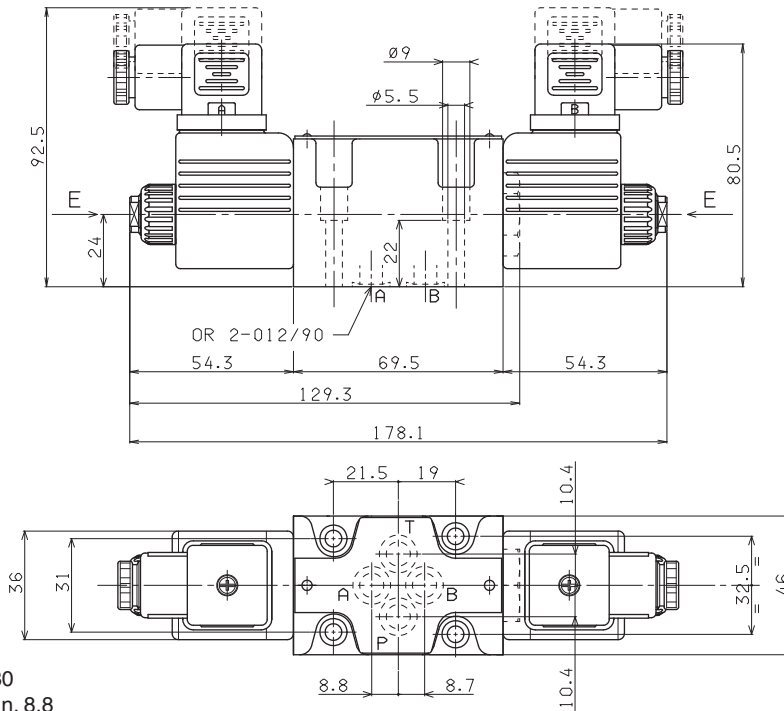

E = Manual override

Fixing screws UNI 5931 M5x30
with material specifications min. 8.8
Tightening torque 5 ÷ 6 Nm / 0.5 ÷ 0.6 Kgm

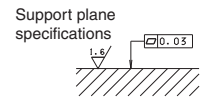

A09 DC COILS



Type of protection (in relation to connector used)	IP 65
Number of cycle	18.000/h
Supply tolerance	±10%
Ambient temperature	-30°C ÷ 60°C
Duty cycle	100% ED
Insulation class wire	H
Weight	0,215 Kg

- The AMP Junior coil and with the flying leads (with or without diode) coils are available in 12V or 24V DC voltage only.
- The Deutsch coil with bidirectional diode is available in 12V DC voltage only.

VOLTAGE (V)	MAX WINDING TEMPERATURE (AMBIENT TEMPERATURE 25°C)	RATED POWER (W)	RESISTANCE AT 20°C (OHM) ±7%
12V	123°C	27	5.3
24V	123°C	27	21.3
48V*	123°C	27	85.3
102V(**)**	123°C	27	392
110V(**)**	123°C	27	448
205V(**)**	123°C	27	1577

** The european low voltage directive is applied to electronical equipments used at a nominal voltages between 50 and 1000 VAC or 75 and 1500 VDC. In conformity with the low directive each part of the manifold or the subplate on which the valve is mounted should be connected to a protective earth with a resistance less than 0.1 ohms.

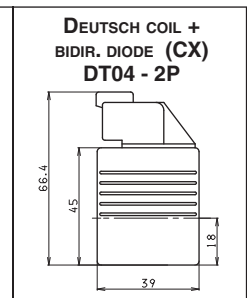
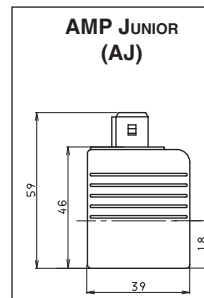

MANUAL WITHOUT CONNECTOR (ES)
MANUAL WITH CONNETOR (E1)

EMERGENCY (COILS WITH HIRSCHMANN CONNECTION)
ROTARY WITHOUT CONNECTOR (P2*)
ROTAN ROTARY TE WITH CONNETOR (P1*)

ROTARY 180° WITHOUT CONNECTOR (R5*)
ROTARY 180° WITH CONNETOR (P5*)

FLYING LEADS (FL)
LEADS + DIODE (LD)

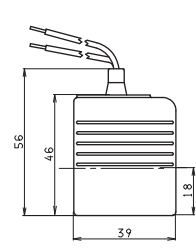
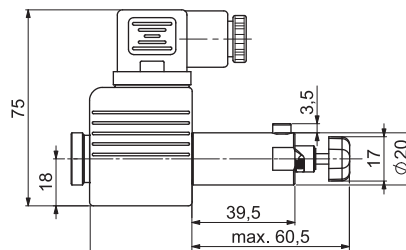
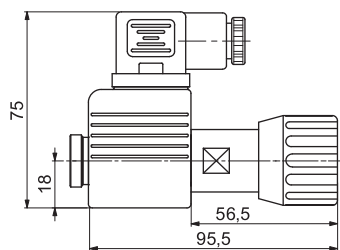
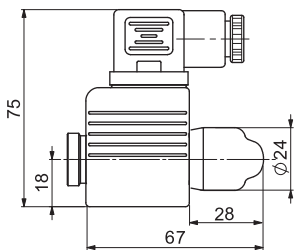

(*) Emergency tightening torque max. 6÷9 Nm / 0.6 ÷ 0.9 Kgm with CH n. 22