

PROPORTIONAL CARTRIDGE

CECS-140-FRPM

PROPORTIONAL VALVES
FLOW REGULATOR
3 WAYS COMBINATION

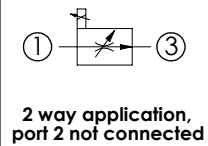
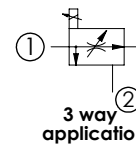
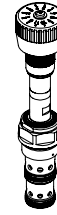
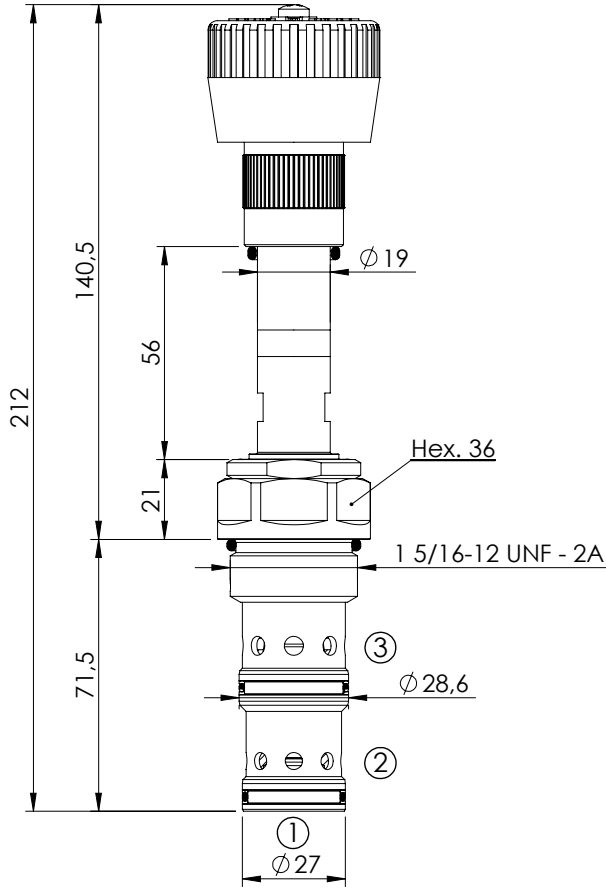

SPECIFICATIONS

Max. operating pressure:	320 bar
Maximum flow (in inlet port ①):	140 l/min
Max. flow ① to ③:	100 l/min (regulated)
Pressure differential (① to ③):	7 - 11 bar
Hysteresis (ramp up and down):	1,5 - 3 %
Coil type:	M15
Voltage:	12- 24 V dc
Max current (12 V dc):	1800 mA
Max current (24 V dc):	1200 mA
Coil resistance (12 V dc):	3,3-5,8 Ω
Coil resistance (24 V dc):	7,2-13 Ω
Weight:	0,6 kg
Cavity:	SAE-16-3N
Installation torque:	130 -145 Nm
Surface protection proportional solenoid:	Coating DIN 50962 Fe8//ZiNi with passivation
Seal kit:	RB100094

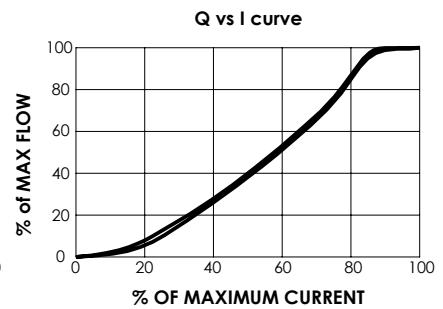
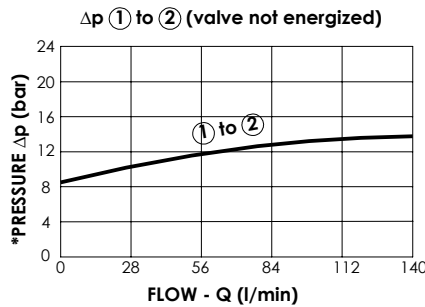
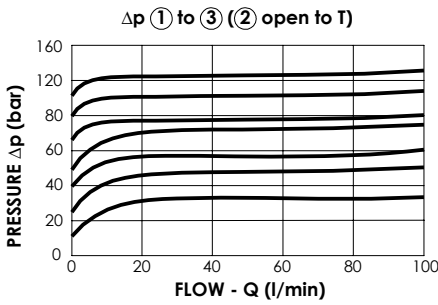

ORDERING CODES

Quick code	Description	Regulated flow range (l/min)	Adjustment type
CE000831	CECS-140-FRPM-15-S16-V320	0 - 15	Handknob
CE000832	CECS-140-FRPM-25-S16-V320	0 - 25	Handknob
CE000833	CECS-140-FRPM-40-S16-V320	0 - 40	Handknob
CE000834	CECS-140-FRPM-50-S16-V320	0 - 50	Handknob
CE000835	CECS-140-FRPM-65-S16-V320	0 - 65	Handknob
CE000836	CECS-140-FRPM-80-S16-V320	0 - 80	Handknob
CE001034	CECS-140-FRPM-100-S16-V320	0 - 100	Handknob