



EQUIPAGGIAMENTI
TECNICI
LAVAGGIO

30.2840.00
PISTOLA RL 82+ARS350 B
GUN RL 82+ARS350 B

I
GB

1

14/01/10

CARATTERISTICHE TECNICHE
SPECIFICATIONS

- PRESSIONE NOMINALE RATED PRESSURE	125 bar – 12.5 MPa (1850 psi)
- PRESSIONE CONSENTITA PERMISSIBLE PRESSURE	140 bar – 14 MPa (2030 psi)
- PORTATA MASSIMA MAX FLOW RATE	80 l/min (21 USG p.m.)
- TEMPERATURA MASSIMA MAX WORKING TEMPERATURE	160° C (320 °F)

MISURE D'INGOMBRO
OVERALL DIMENSIONS

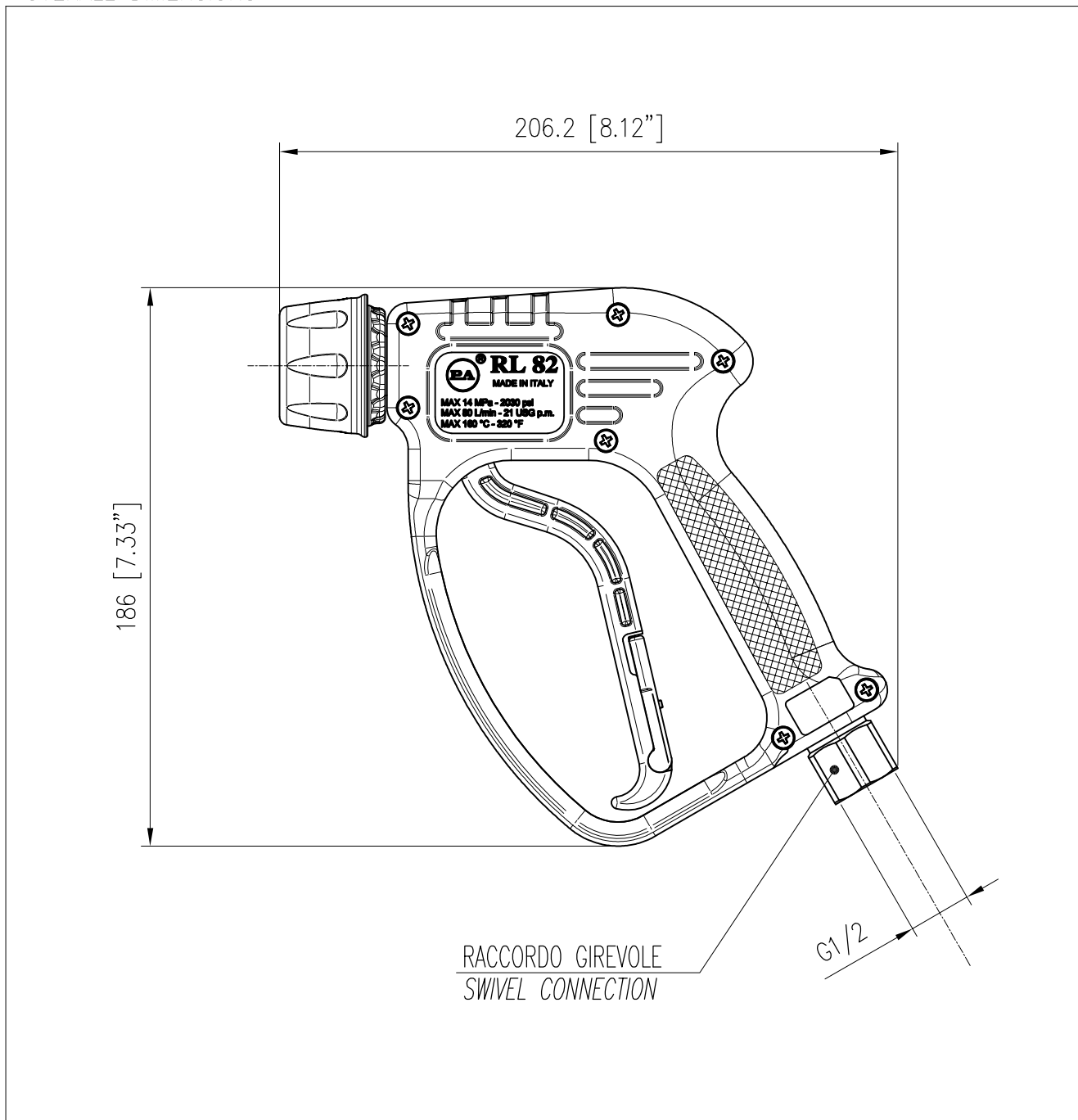



EQUIPAGGIAMENTI
TECNICI
LAVAGGIO

30.2860.00
PISTOLA RL 82+ARS178 B
GUN RL 82+ARS178 B

I

GB

1

14/01/10

CARATTERISTICHE TECNICHE
SPECIFICATIONS

- PRESSIONE NOMINALE RATED PRESSURE	125 bar – 12.5 MPa (1850 psi)
- PRESSIONE CONSENTITA PERMISSIBLE PRESSURE	140 bar – 14 MPa (2030 psi)
- PORTATA MASSIMA MAX FLOW RATE	80 l/min (21 USG p.m.)
- TEMPERATURA MASSIMA MAX WORKING TEMPERATURE	160° C (320 °F)

MISURE D'INGOMBRO
OVERALL DIMENSIONS

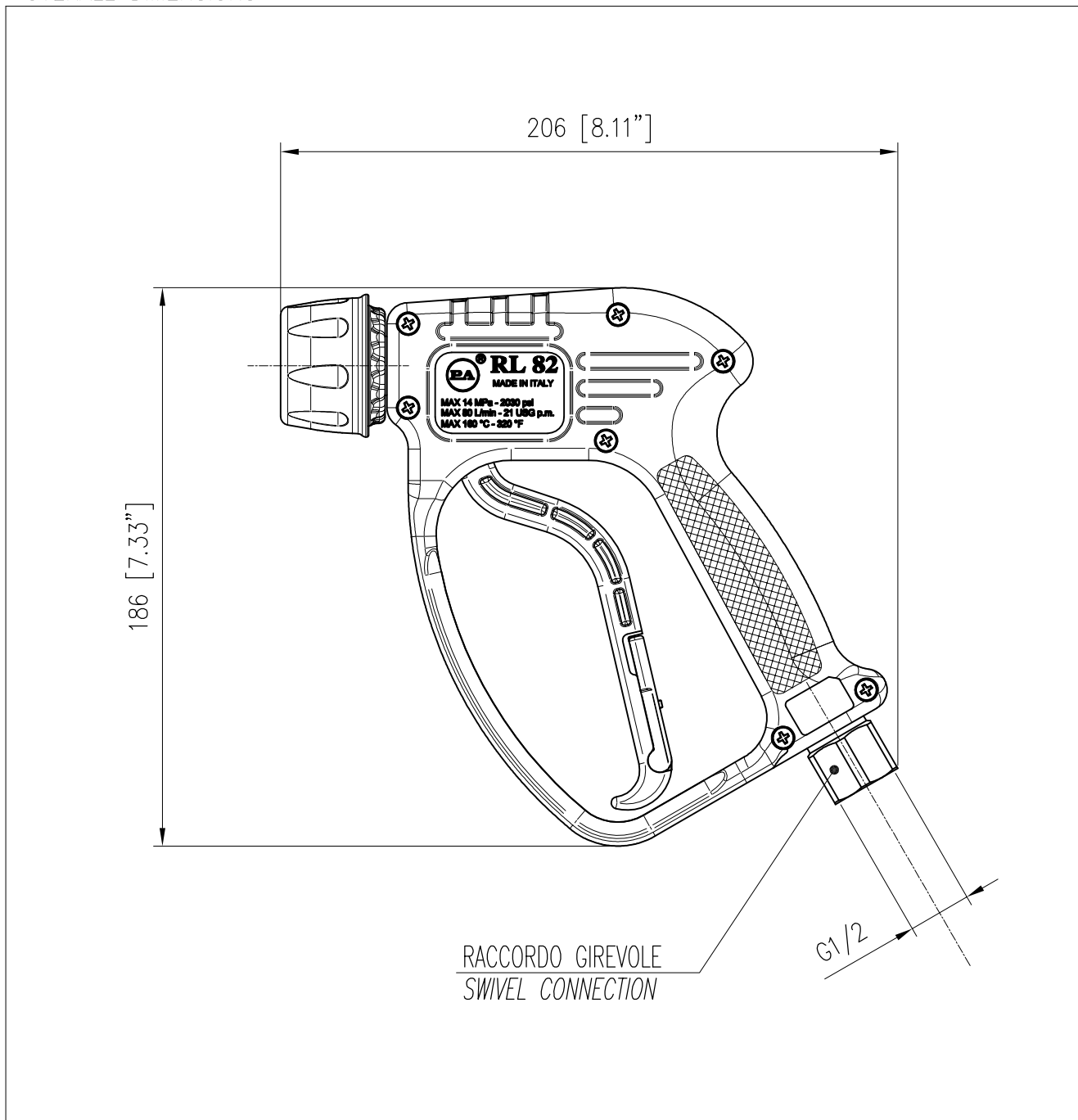



EQUIPAGGIAMENTI
TECNICI
LAVAGGIO

30.2880.00
PISTOLA RL 82+ARS25 B
GUN RL 82+ARS25 B

I

GB

1

14/01/10

CARATTERISTICHE TECNICHE
SPECIFICATIONS

- PRESSIONE NOMINALE RATED PRESSURE	125 bar – 12.5 MPa (1850 psi)
- PRESSIONE CONSENTITA PERMISSIBLE PRESSURE	140 bar – 14 MPa (2030 psi)
- PORTATA MASSIMA MAX FLOW RATE	80 l/min (21 USG p.m.)
- TEMPERATURA MASSIMA MAX WORKING TEMPERATURE	160° C (320 °F)

MISURE D'INGOMBRO
OVERALL DIMENSIONS

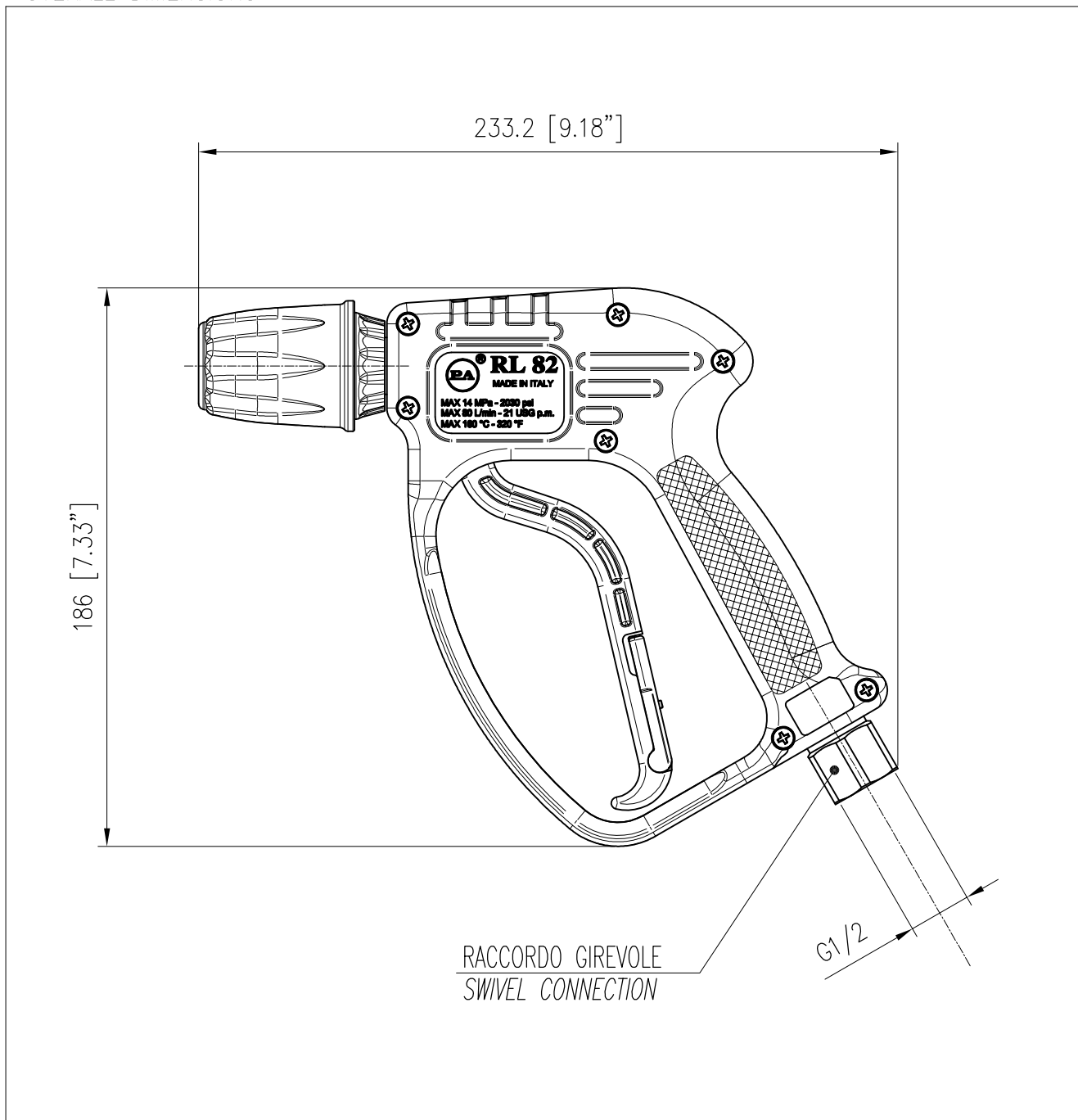



P.A. S.p.A.
Via Milano, 13
42048 Rubiera, Reggio Emilia - Italy
Tel +39.0522.623611
Fax +39.0522.629600
info@pa-etl.it

www.pa-etl.it



COMPANY WITH QUALITY MANAGEMENT
SYSTEM CERTIFIED BY DNV
= ISO 9001 =