

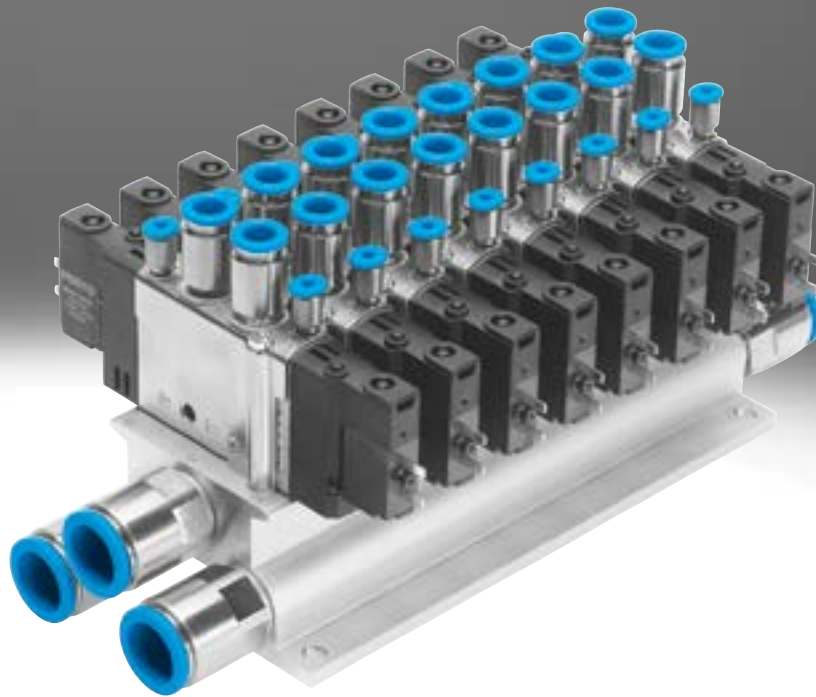

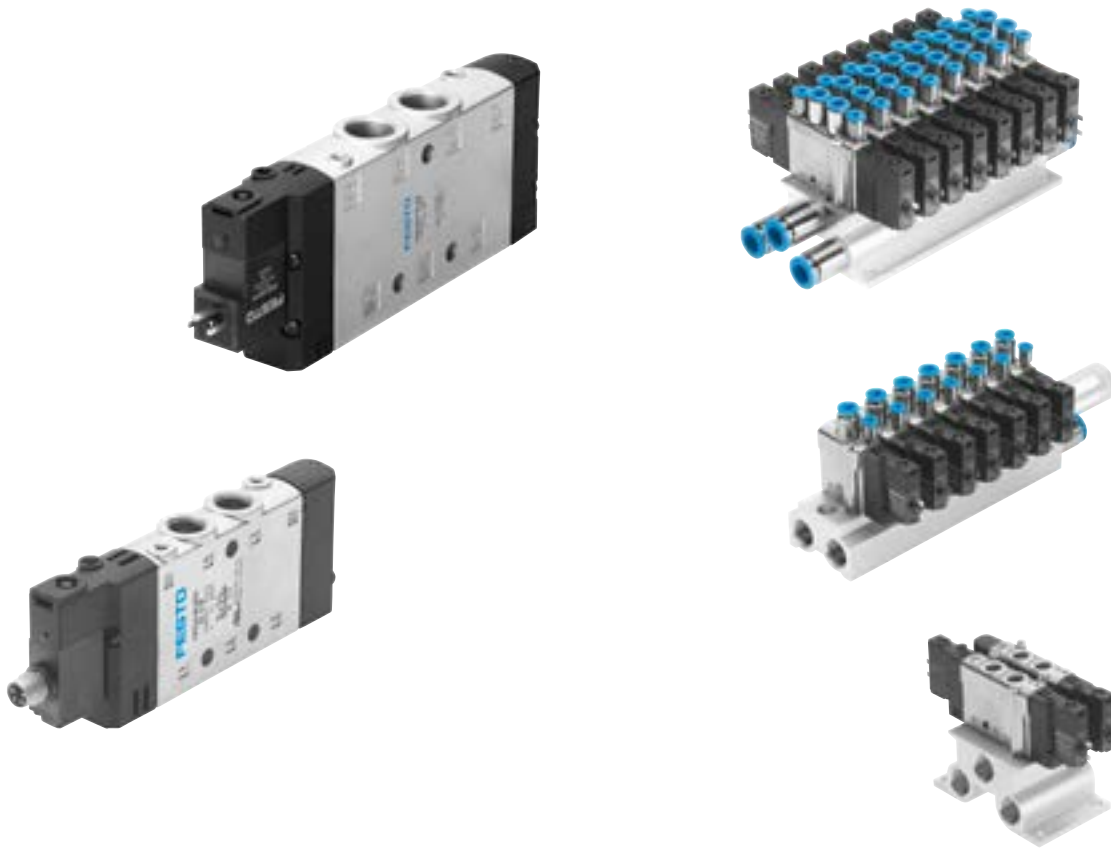

## Universal valve CPE

**FESTO**



Key features



Variants	Parameter	Advantages	
<p>Functions (selection)</p> <p>3/2-way valve with external pilot air supply, normally closed</p>	<p>-  - Width                      10 mm                      14 mm                      18 mm                      24 mm</p>	<p>Performance-optimised sizes:                      The solenoid valves CPE, Compact Performance, are distinguished by their minimal width and low power consumption at high flow rates.</p>	<p>Short tubing lengths requiring minimal air volume:</p> <ul style="list-style-type: none"> <li>• Short switching times</li> <li>• Very short reaction times</li> </ul>
<p>5/2-way single solenoid valve with Internal pilot air supply</p>	<p>-  - Flow rate                      180 ... 3200 l/min</p>	<p>They can be mounted directly on site:</p> <ul style="list-style-type: none"> <li>• On the cylinder</li> <li>• On moving system components</li> <li>• Flexible installation through individual mounting</li> </ul>	<p>Optimised installations:</p> <ul style="list-style-type: none"> <li>• Shorter machine cycles</li> <li>• Larger quantities</li> <li>• Low power consumption</li> </ul> <p>Convenient manual override.</p>
<p>5/2-way double pilot valve with external pilot air supply</p>	<p>-  - <b>Note</b>                      The 5/3-way solenoid valve remains in the previous switching position if both solenoid coils are energised simultaneously.                      If neither solenoid coil is energised, the spring force moves the valve to its mid-position.</p>	<p>CPE10, CPE14 and CPE18:                      Simple manifold design consisting of fixed-grid manifold blocks made from stable aluminium with 2 to 10 valve positions or modular manifold blocks made from durable polymer.</p>	<p>The connecting cables NEBV for sizes CPE10 and CPE14 have integrated current reduction.                      All CPE valves therefore have a duty cycle of 100%.</p>
<p>5/3-way valve with external pilot air supply, normally closed</p>			

## Key features

### Solenoid valves with plug pins

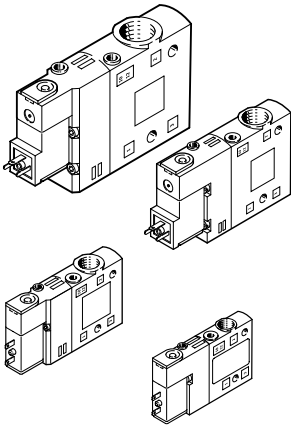

- Width 10 mm, 14 mm, 18 mm and 24 mm
- 3/2-, 5/2- and 5/3-way valves
- Internal or external pilot air supply available
- 24 V DC for all widths
- 110 or 220 V AC for widths 18 and 24
- Manual override, non-detenting and detenting via tool
- Width 10 mm available with M5 insert
- All widths available with QS fittings in 2 sizes

### Solenoid valves with round plug

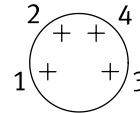
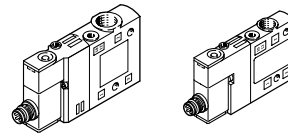

- Widths 10 mm and 14 mm
- 3/2-, 5/2- and 5/3-way valves
- Internal or external pilot air supply available
- 24 V DC
- Manual override, non-detenting and detenting via tool
- Round plug, M8x1, 4-pin

### CPE18 basic valve with interface to ISO 15218

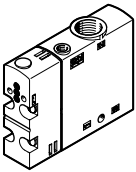

- Width 18 mm
- 3/2-, 5/2- and 5/3-way valves
- Internal or external pilot air supply available

### Pilot valve with interface to ISO 15218

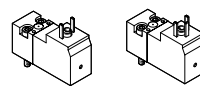

- For 12, 24 V DC and 24 V AC without PE conductor
- For 110 and 220 V AC with PE conductor
- 3/2-way valve
- Manual override non-detenting

### Adapter VAVE



Fits plug pins with plug pattern ZC for CPE10/CPE14

### Combination of basic valve CPE18 with pilot valve

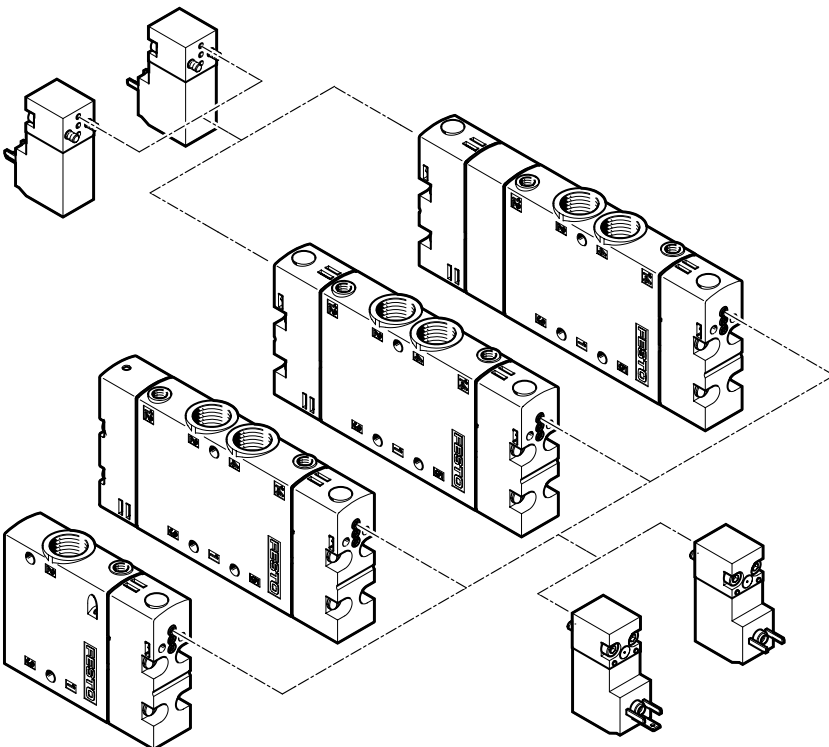

## Key features

### Manifold block for fixed-grid manifold

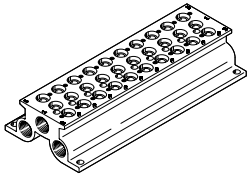

- For valve widths 10, 14 and 18 mm
- For 5/2- and 5/3-way valves
- 2 to 10 valve positions

### Manifold block for fixed-grid manifold

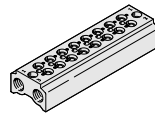

- For valve widths 10, 14 and 18 mm
- For 3/2-way valves
- 2 to 10 valve positions

### Retaining bracket set



- Retaining bracket for 5/2 or 5/3-way valve

### Retaining bracket set

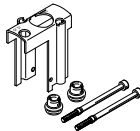

- Retaining bracket for 3/2-way valve

### Cover plate for vacant position



- Reserved position cover for 5/2- or 5/3-way valve

### Cover plate for vacant position



- Reserved position cover for 3/2-way valve

### Manifold block with air supply

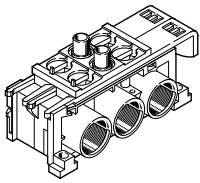

- 2 valve positions
- For CPE10, CPE14 or CPE18
- For 5/2- and 5/3-way valves
- Ducts 1, 3 and 5 can have closed or open ends
- Ducts closed when the manifold is full or when pressure zones are being used

### Manifold block for expansion

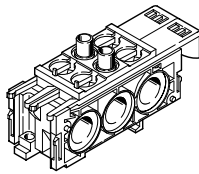

- 2 valve positions
- For CPE10, CPE14 or CPE18
- For 5/2- and 5/3-way valves
- Ducts 1, 3 and 5 can have closed or open ends

### Manifold block with air supply

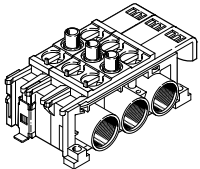

- 3 valve positions
- For CPE10, CPE14 or CPE18
- For 5/2- and 5/3-way valves
- Ducts 1, 3 and 5 can have closed or open ends
- Ducts closed when the manifold is full or when pressure zones are being used

### End plate for additional air supply

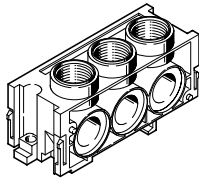

- For CPE10, CPE14 or CPE18
- Required for manifolds with more than 6 valves or separate pressure zones
- Ports 1, 3 and 5 at rear and on top

### Cover plate for vacant position

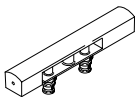

- Versions
- Reserved position cover for 5/2- or 5/3-way valve

### Modular manifold block with cover plate

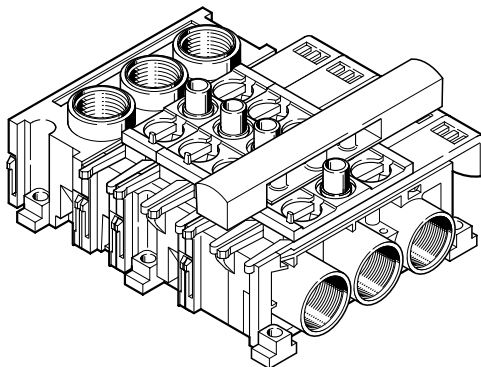

## Key features

**Mounting on fixed-grid manifold block for CPE10, CPE14 and CPE18**

- Simple design comprising compact valve manifold assemblies with in-line valves
- Mounting with stable retaining bracket and special moulded seal guarantee leak-free assembly
- 2 to 10 valve positions
- Aluminium mounting rail provides high stability
- High flow rates with air supply on both sides for duct 1
- High exhaust capacity with output on both sides for ducts 3 and 5
- Different pressure and exhaust zones can be created using separators, which are clamped at the separation points in ducts 1, 3 and 5

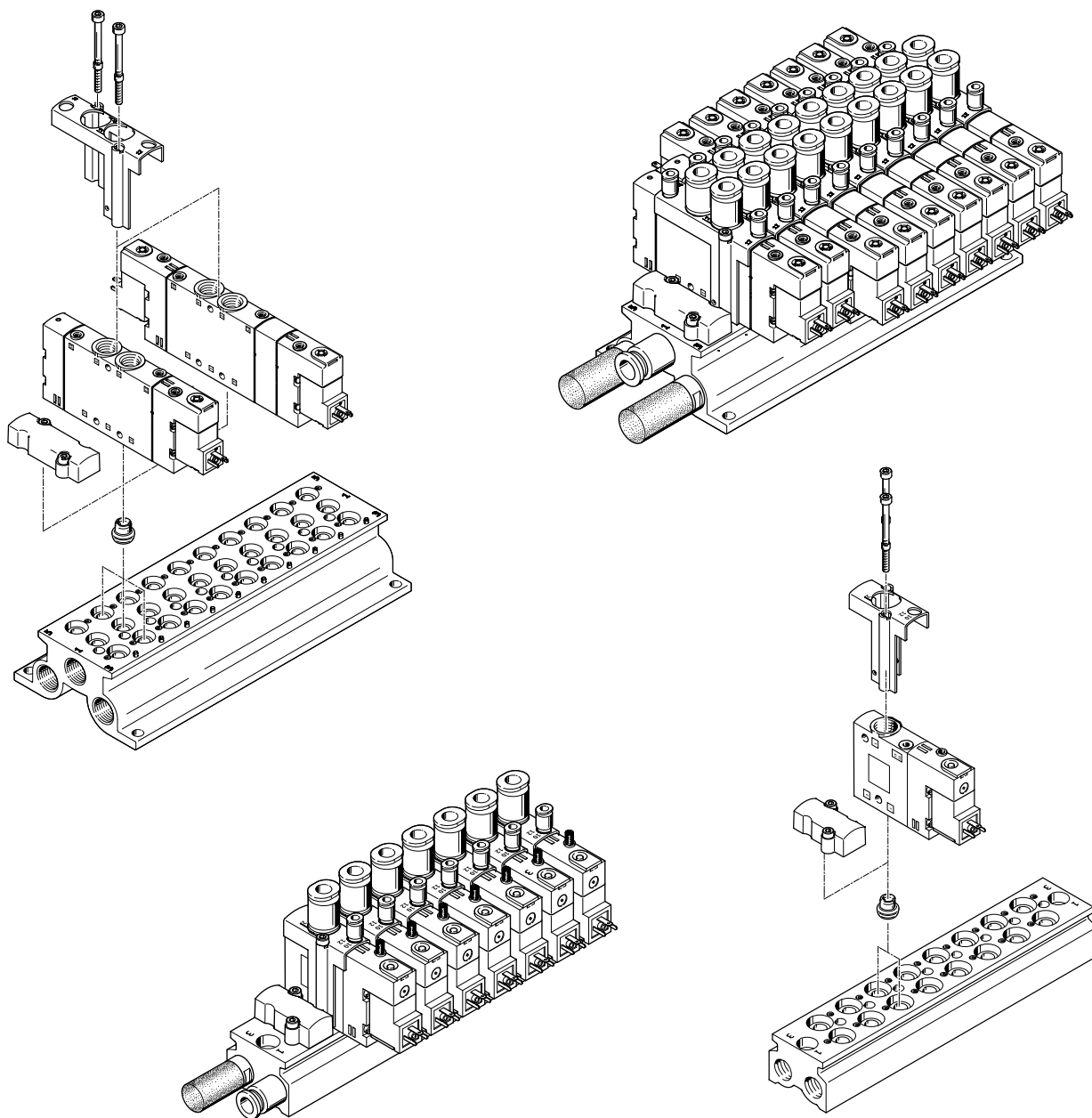

## Key features

### Mounting on fixed-grid manifold block for CPE10, CPE14 and CPE18

- Creating a valve manifold with modular manifold blocks made from high impact, glass fibre reinforced polyamide
- Different pressure zones can be created using basic and expansion blocks with closed supply and exhaust ducts
- Air supply and exhaust can be connected on both sides using an additional end block
- Air supply and exhaust can be connected to the end block, at the rear and at the top
- No screws required for mounting thanks to slides and clips

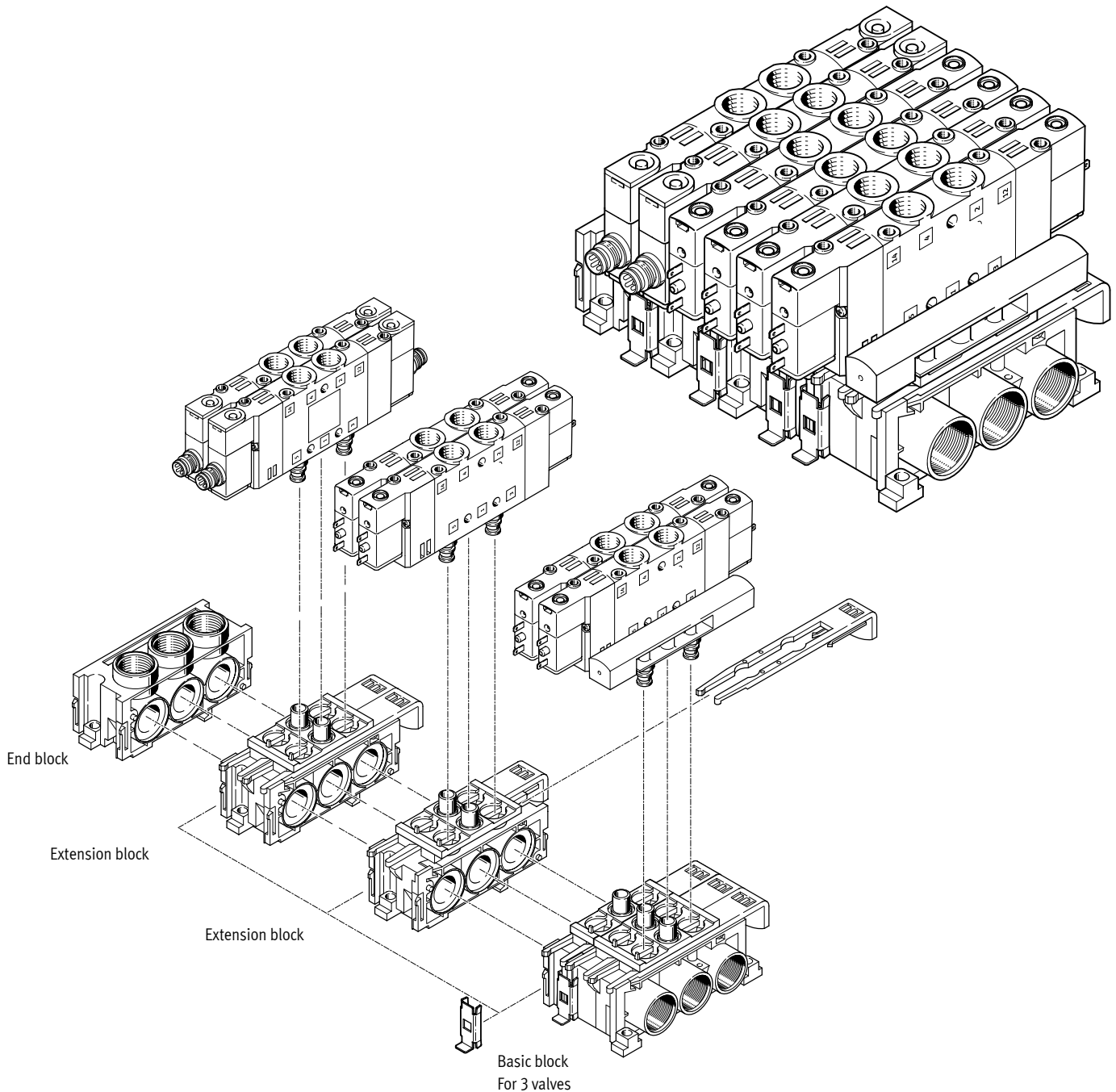

## Key features – Mounting

### Individual valve mounting CPE

#### Cylinder mounting

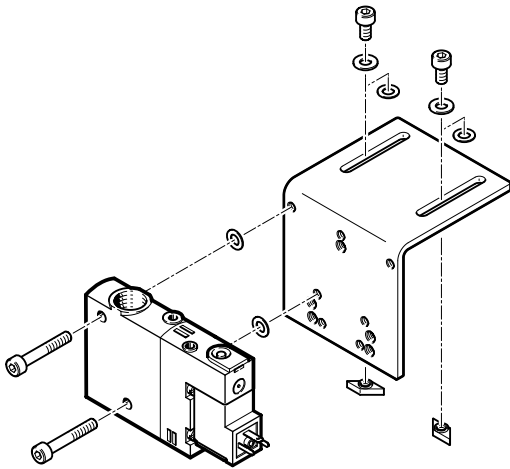

For mounting individual valves directly on a drive.

The solenoid valves are provided with two through-holes for attaching to the cylinder mounting DAVM-MW-V1...-V. Mounting is only possible on the side on which the pneumatic connections are located.

The relevant screw set is included when the cylinder mounting DAVM-MW-V1...-V is ordered.

Product range overview – Widths 10 mm and 14 mm

Width	Circuit symbol	Type	Electrical connection		Operating voltage [V DC]	Working port						→ Page/ Internet
			Plug pattern ZC	M8x1		M5	M7	G1/8	QS4	QS6	QS8	
10 mm	<b>3/2-way single solenoid valve, normally closed</b>											
		CPE10-M1BH-3GL...	■	-	24	■	■	-	■	■	-	26
		CPE10-M1CH-3GL...	-	■	24	-	■	-	-	-	-	-
	<b>3/2-way single solenoid valve, normally open</b>											
		CPE10-M1BH-3OL...	■	-	24	■	■	-	■	■	-	26
		CPE10-M1CH-3OL...	-	■	24	-	■	-	-	-	-	-
	<b>5/2-way single solenoid valve</b>											
		CPE10-M1BH-5L...	■	-	24	■	■	-	■	■	-	26
		CPE10-M1CH-5L...	-	■	24	-	■	-	-	-	-	-
	<b>5/2-way double solenoid valve</b>											
		CPE10-M1BH-5J...	■	-	24	■	■	-	■	■	-	26
		CPE10-M1CH-5J...	-	■	24	-	■	-	-	-	-	-
	<b>5/3-way solenoid valve, normally closed, mid-position valve</b>											
		CPE10-M1BH-5/3G...	■	-	24	■	■	-	■	■	-	27
		CPE10-M1CH-5/3G...	-	■	24	-	■	-	-	-	-	-
	<b>5/3-way solenoid valve, normally open, mid-position valve</b>											
		CPE10-M1BH-5/3B...	■	-	24	■	■	-	■	■	-	27
		CPE10-M1CH-5/3B...	-	■	24	-	■	-	-	-	-	-
<b>5/3-way solenoid valve, normally exhausted, mid-position valve</b>												
	CPE10-M1BH-5/3E...	■	-	24	■	■	-	■	■	-	27	
	CPE10-M1CH-5/3E...	-	■	24	-	■	-	-	-	-	-	
14 mm	<b>3/2-way single solenoid valve, normally closed</b>											
		CPE14-M1BH-3GL...	■	-	24	-	-	■	-	■	■	43
		CPE14-M1CH-3GL...	-	■	24	-	-	■	-	-	-	-
	<b>3/2-way single solenoid valve, normally open</b>											
		CPE14-M1BH-3OL...	■	-	24	-	-	■	-	■	■	43
		CPE14-M1CH-3OL...	-	■	24	-	-	■	-	-	-	-
	<b>5/2-way single solenoid valve</b>											
		CPE14-M1BH-5L...	■	-	24	-	-	■	-	■	■	43
		CPE14-M1CH-5L...	-	■	24	-	-	■	-	-	-	-
	<b>5/2-way double solenoid valve</b>											
		CPE14-M1BH-5J...	■	-	24	-	-	■	-	■	■	43
		CPE14-M1CH-5J...	-	■	24	-	-	■	-	-	-	-
	<b>5/3-way solenoid valve, normally closed, mid-position valve</b>											
		CPE14-M1BH-5/3G...	■	-	24	-	-	■	-	■	■	44
		CPE14-M1CH-5/3G...	-	■	24	-	-	■	-	-	-	-
	<b>5/3-way solenoid valve, normally open, mid-position valve</b>											
		CPE14-M1BH-5/3B...	■	-	24	-	-	■	-	■	■	44
		CPE14-M1CH-5/3B...	-	■	24	-	-	■	-	-	-	-
<b>5/3-way solenoid valve, normally exhausted, mid-position valve</b>												
	CPE14-M1BH-5/3E...	■	-	24	-	-	■	-	■	■	44	
	CPE14-M1CH-5/3E...	-	■	24	-	-	■	-	-	-	-	



Product range overview – Width 18 mm

Width	Circuit symbol	Type	Operating voltage		Working port			→ Page/ Internet	
			[V DC]	[V AC]	G1/4	QS8	QS10		
18 mm		<b>3/2-way single solenoid valve, normally closed</b>							
		CPE18-M1H-3GL...	24	–	■	■	■	59	
		CPE18-M2H-3GL...	–	110	■	■	■		
		CPE18-M3H-3GL...	–	220	■	■	■		
			CPE18-P1-3GL...1/4	12 <sup>1)</sup>	110 <sup>1)</sup>	■	–	–	66
				24 <sup>1)</sup>	230 <sup>1)</sup>	■	–	–	
		<b>3/2-way single solenoid valve, normally open</b>							
		CPE18-M1H-3OL...	24	–	■	■	■	59	
		CPE18-M2H-3OL...	–	110	■	■	■		
		CPE18-M3H-3OL...	–	220	■	■	■		
			CPE18-P1-3OL...1/4	12 <sup>1)</sup>	110 <sup>1)</sup>	■	–	–	66
				24 <sup>1)</sup>	230 <sup>1)</sup>	■	–	–	
		<b>5/2-way single solenoid valve</b>							
		CPE18-M1H-5L...	24	–	■	■	■	60	
		CPE18-M2H-5L...	–	110	■	■	■		
		CPE18-M3H-5L...	–	220	■	■	■		
			CPE18-P1-5L...1/4	12 <sup>1)</sup>	110 <sup>1)</sup>	■	–	–	66
				24 <sup>1)</sup>	230 <sup>1)</sup>	■	–	–	
		<b>5/2-way double solenoid valve</b>							
		CPE18-M1H-5J...	24	–	■	■	■	60	
		CPE18-M2H-5J...	–	110	■	■	■		
		CPE18-M3H-5J...	–	220	■	■	■		
			CPE18-P1-5J...1/4	12 <sup>1)</sup>	110 <sup>1)</sup>	■	–	–	66
				24 <sup>1)</sup>	230 <sup>1)</sup>	■	–	–	
		<b>5/3-way solenoid valve, normally closed, mid-position valve</b>							
		CPE18-M1H-5/3G...	24	–	■	■	■	61	
		CPE18-M2H-5/3G...	–	110	■	■	■		
		CPE18-M3H-5/3G...	–	220	■	■	■		
		CPE18-P1-5/3G...1/4	12 <sup>1)</sup>	110 <sup>1)</sup>	■	–	–	66	
			24 <sup>1)</sup>	230 <sup>1)</sup>	■	–	–		
	<b>5/3-way solenoid valve, normally open, mid-position valve</b>								
	CPE18-M1H-5/3B...	24	–	■	■	■	61		
	CPE18-M2H-5/3B...	–	110	■	■	■			
	CPE18-M3H-5/3B...	–	220	■	■	■			
		CPE18-P1-5/3B...1/4	12 <sup>1)</sup>	110 <sup>1)</sup>	■	–	–	66	
			24 <sup>1)</sup>	230 <sup>1)</sup>	■	–	–		
	<b>5/3-way solenoid valve, normally exhausted, mid-position valve</b>								
	CPE18-M1H-5/3E...	24	–	■	■	■	61		
	CPE18-M2H-5/3E...	–	110	■	■	■			
	CPE18-M3H-5/3E...	–	220	■	■	■			
		CPE18-P1-5/3E...1/4	12 <sup>1)</sup>	110 <sup>1)</sup>	■	–	–	66	
			24 <sup>1)</sup>	230 <sup>1)</sup>	■	–	–		

1) Operating voltage dependent on separately ordered pilot valve

Product range overview – Width 24 mm

Width	Circuit symbol	Type	Operating voltage		Working port			→ Page/ Internet
			[V DC]	[V AC]	G3/8	QS10	QS12	
24 mm		<b>3/2-way single solenoid valve, normally closed</b>						
		CPE24-M1H-3GL...	24	–	■	■	■	81
		CPE24-M2H-3GL...	–	110	■	■	■	
	CPE24-M3H-3GL...	–	220	■	■	■		
		<b>3/2-way single solenoid valve, normally open</b>						
		CPE24-M1H-3OL...	24	–	■	■	■	81
		CPE24-M2H-3OL...	–	110	■	■	■	
	CPE24-M3H-3OL...	–	220	■	■	■		
		<b>5/2-way single solenoid valve</b>						
		CPE24-M1H-5L...	24	–	■	■	■	82
		CPE24-M2H-5L...	–	110	■	■	■	
	CPE24-M3H-5L...	–	220	■	■	■		
		<b>5/2-way double solenoid valve</b>						
		CPE24-M1H-5J...	24	–	■	■	■	82
		CPE24-M2H-5J...	–	110	■	■	■	
	CPE24-M3H-5J...	–	220	■	■	■		
		<b>5/3-way solenoid valve, normally closed, mid-position valve</b>						
		CPE24-M1H-5/3G...	24	–	■	■	■	83
		CPE24-M2H-5/3G...	–	110	■	■	■	
	CPE24-M3H-5/3G...	–	220	■	■	■		
		<b>5/3-way solenoid valve, normally open, mid-position valve</b>						
		CPE24-M1H-5/3B...	24	–	■	■	■	83
		CPE24-M2H-5/3B...	–	110	■	■	■	
	CPE24-M3H-5/3B...	–	220	■	■	■		
	<b>5/3-way solenoid valve, normally exhausted, mid-position valve</b>							
	CPE24-M1H-5/3E...	24	–	■	■	■	83	
	CPE24-M2H-5/3E...	–	110	■	■	■		
CPE24-M3H-5/3E...	–	220	■	■	■			

Product range overview – Functions

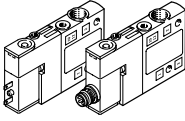
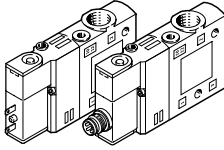
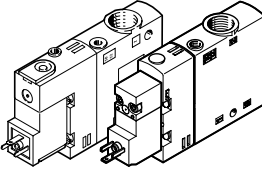
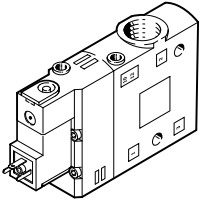
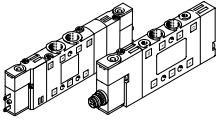
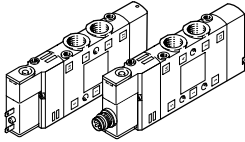
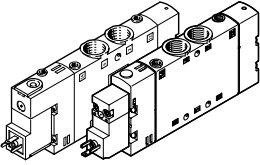
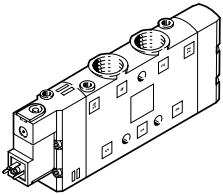
3/2-way valves					
Type		CPE10	CPE14	CPE18	CPE24
Width		10 mm	14 mm	18 mm	24 mm
<b>Standard nominal flow rate [l/min]</b>					
Thread	M5	190	–	–	–
	M7	400	–	–	–
	G1/8	–	900	–	–
	G1/4	–	–	1300	–
	G3/8	–	–	–	2500
Push-in connector	QS-4	190	–	–	–
	QS-6	300	510	–	–
	QS-8	–	810	850	–
	QS-10	–	–	1000	1250
	QS-12	–	–	–	1650
<b>5/2-way valves, single solenoid</b>					
					
Type		CPE10	CPE14	CPE18	CPE24
Width		10 mm	14 mm	18 mm	24 mm
<b>Standard nominal flow rate [l/min]</b>					
Thread	M5	180	–	–	–
	M7	350	–	–	–
	G1/8	–	800	–	–
	G1/4	–	–	1300	–
	G3/8	–	–	–	2900
Push-in connector	QS-4	180	–	–	–
	QS-6	320	400	–	–
	QS-8	–	680	850	–
	QS-10	–	–	1000	1250
	QS-12	–	–	–	1650
<b>Operating voltage</b>					
12 V DC		–	–	■	–
24 V DC/AC		■/–	■/–	■/■	■/–
110 V AC		–	–	■	■
230 V AC		–	–	■	■
Datasheet → Page		20	35	53	75

Product range overview – Functions

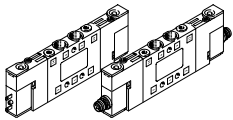
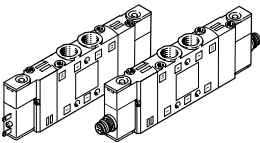
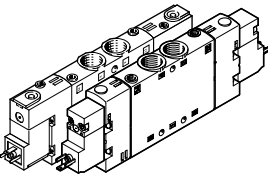
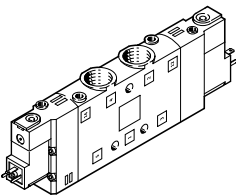
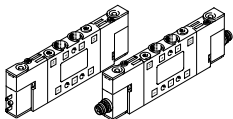
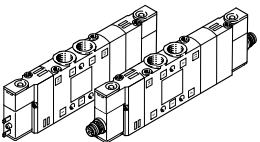
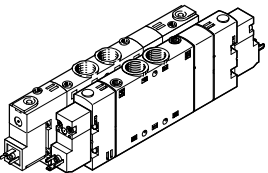
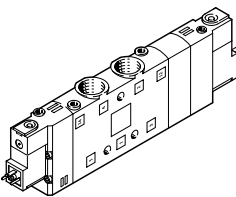
<b>5/2-way valves, double solenoid</b>					
Type		CPE10	CPE14	CPE18	CPE24
Width		10 mm	14 mm	18 mm	24 mm
<b>Standard nominal flow rate [l/min]</b>					
Thread	M5	180	–	–	–
	M7	350	–	–	–
	G1/8	–	800	–	–
	G1/4	–	–	1300	–
	G3/8	–	–	–	3200
Push-in connector	QS-4	180	–	–	–
	QS-6	320	400	–	–
	QS-8	–	680	850	–
	QS-10	–	–	1000	1250
	QS-12	–	–	–	1650
<b>5/3-way valves</b>					
					
Type		CPE10	CPE14	CPE18	CPE24
Width		10 mm	14 mm	18 mm	24 mm
<b>Standard nominal flow rate [l/min]</b>					
Thread	M5	180	–	–	–
	M7	250 ... 350	–	–	–
	G1/8	–	700 ... 750	–	–
	G1/4	–	–	1200 ... 1450	–
	G3/8	–	–	–	2600 ... 3000
Push-in connector	QS-4	180	–	–	–
	QS-6	250 ... 300	370 ... 410	–	–
	QS-8	–	570 ... 720	780 ... 850	–
	QS-10	–	–	1000 ... 1050	1250
	QS-12	–	–	–	1600 ... 1650
<b>Operating voltage</b>					
12 V DC		–	–	■	–
24 V DC/AC		■/–	■/–	■/■	■/–
110 V AC		–	–	■	■
230 V AC		–	–	■	■
Datasheet → Page		20	35	53	75

## Peripherals overview

## Individual valve – CPE10 and CPE14

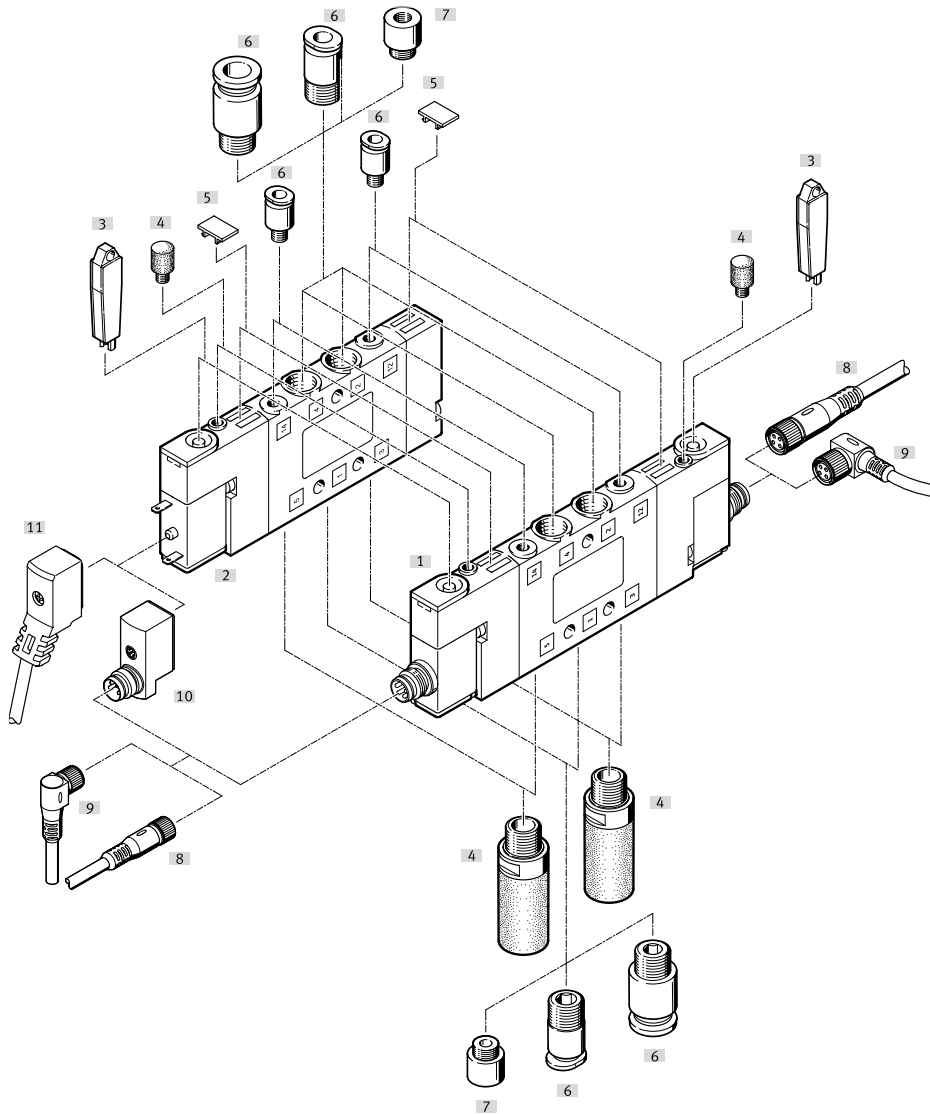

## Accessories – Individual valve

	Type	Description	CPE10	CPE14	→ Page/Internet
[1]	Solenoid valve	CPE...	■	■	cpe
[2]	Solenoid valve	CPE...	■	■	cpe
[3]	Manual override tool	AHB...	■	■	86
[4]	Silencer	U... or UC...	■	■	86
[5]	Inscription label	IBS-6x10	■	■	86
[6]	Push-in fittings	QS...	■	■	qs
[7]	M7 to M5 reducer	–	■	–	–
[8]	Connecting cable	NEBU-M8G...	■	■	85
[9]	Connecting cable	NEBU-M8W...	■	■	85
[10]	Adapter	VAVE-C8...	■	■	85
[11]	Connecting cable	NEBV-Z4...	■	■	85
–	2 to 1 distributor	NEDY...	■	■	85

## Peripherals overview

### Individual valve – CPE18 and CPE24

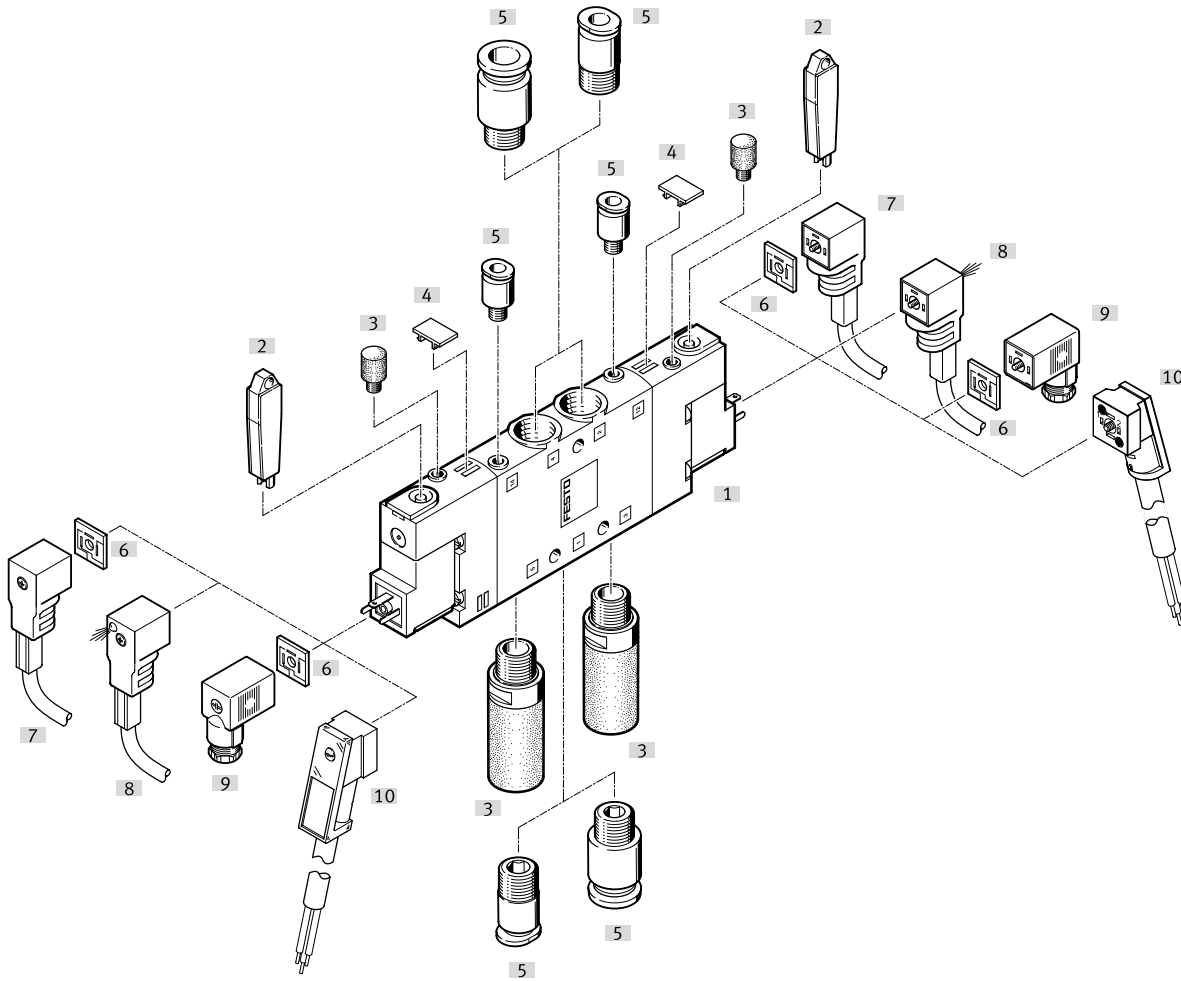

#### Accessories – Individual valve

	Type	Description	CPE18	CPE24	→ Page/Internet
[1]	Solenoid valve	CPE...	■	■	cpe
[2]	Manual override tool	AHB...	■	■	86
[3]	Silencer	U... or UC...	■	■	86
[4]	Inscription label	IBS-6x10	■	■	86
[5]	Push-in fittings	QS...	■	■	qs
[6]	Illuminating seal	MEB...LD	■	■	86
[7]	Plug socket with cable	KMEB-1...	■	■	86
[8]	Plug socket with cable	KMEB-1...	■	■	86
[9]	Plug socket	MSSD-EB...	■	■	86
[10]	Plug socket with cable	KMEB-2...	■	■	86

## System overview

### Fixed-grid manifold assembly

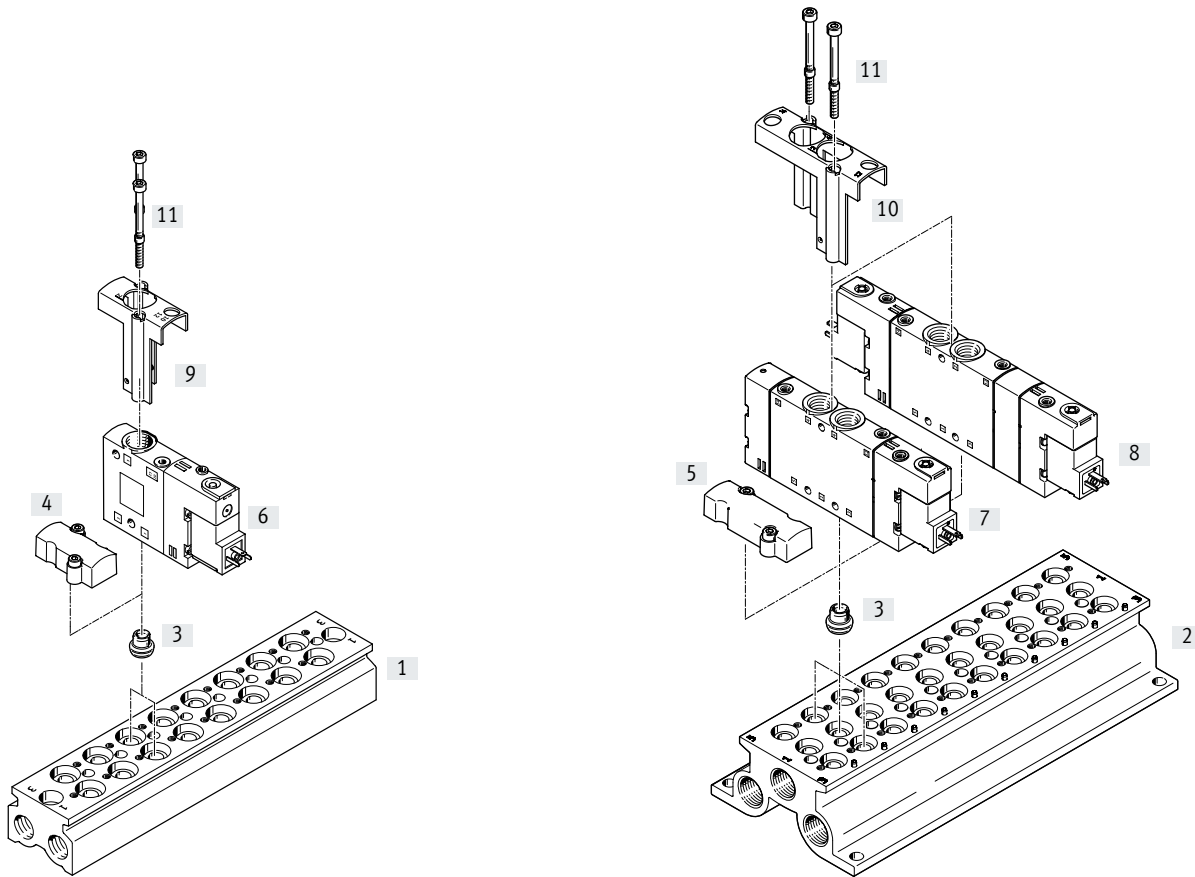

#### Example of manifold assembly – CPE18

	Type	Description	→ Page/Internet		
			CPE10	CPE14	CPE18
[1] Manifold block	CPE18-3/2-PRS...	For 3/2-way valves	31	48	70
[2] Manifold block	CPE18-PRS...	For 5/2-way and 5/3-way valves	29	46	68
[3] Seal	CPV18-VI-P.1/4-150	-	29	46	70
[4] Cover plate	CPE18-RP3	For fitting on vacant positions for 3/2-way valves	31	48	70
[5] Cover plate	CPE18-RP	For fitting on vacant positions for 5/2- and 5/3-way valves	29	46	68
[6] 3/2-way valve	CPE18...	-	26	43	59
[7] 5/2-way valve	CPE18...	-	26	43	60
[8] 5/3-way valve	CPE18...	-	27	44	61
[9] Retaining bracket	CPE18-H3-50	Retaining bracket for 3/2-way valve	31	48	70
[10] Retaining bracket	CPE18-H5-50	Retaining bracket for 5/2- and 5/3-way valve	29	46	68
[11] Screw	M4X65-8.8-VS-100	-	29	46	70

## Peripherals overview

### Accessories – Fixed-grid manifold assembly CPE10 and CPE14

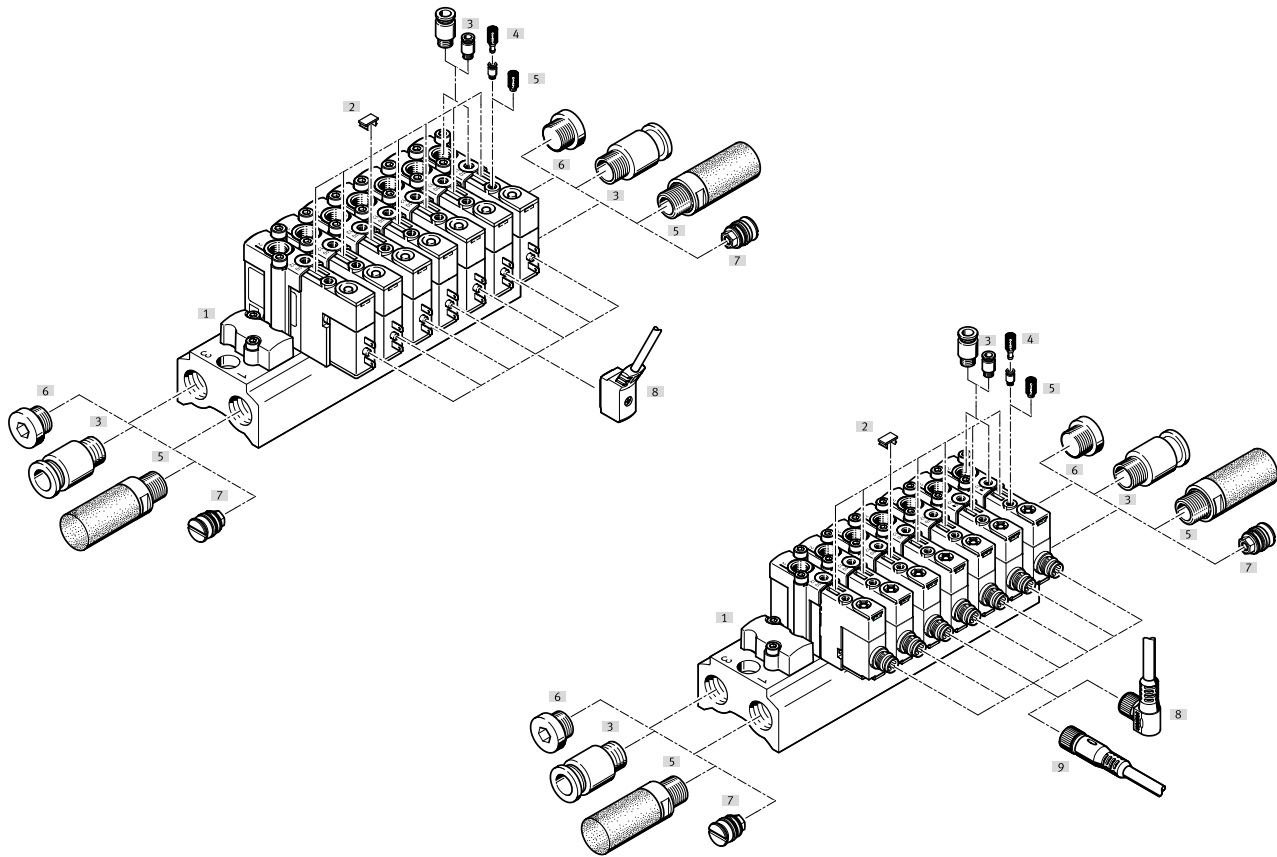

Accessories		Type	Description	CPE10	CPE14	→ Page/Internet
[1]	Solenoid valve	CPE...	–	■	■	cpe
[2]	Inscription label	IBS-6x10	–	■	■	86
[3]	Push-in fittings	QS...	For tubing	■	■	qs
[4]	M7 to M5 reducer	–	Included in the scope of delivery	■	–	–
[5]	Silencer	U... or UC...	For port 3, 5, 82 or 84	■	■	86
[6]	Blanking plug	B...	–	■	■	86
[7]	Separator	VABD..., PRSV...	For fitting on the manifold block	■	■	86
[8]	Connecting cable	NEBV-Z4...	Plug pattern ZC with holding current reduction, protective circuit, signal status indication	■	■	85
	Connecting cable	NEBU-M8W...	Socket M8x1, angled	■	■	85
[9]	Connecting cable	NEBU-M8G...	Socket M8x1, straight	■	■	85
–	2 to 1 distributor	NEDY...	2x socket plug pattern ZC on 1x plug, M8x1 or M12x1	■	■	85



## Peripherals overview

## Accessories – Fixed-grid manifold assembly CPE18

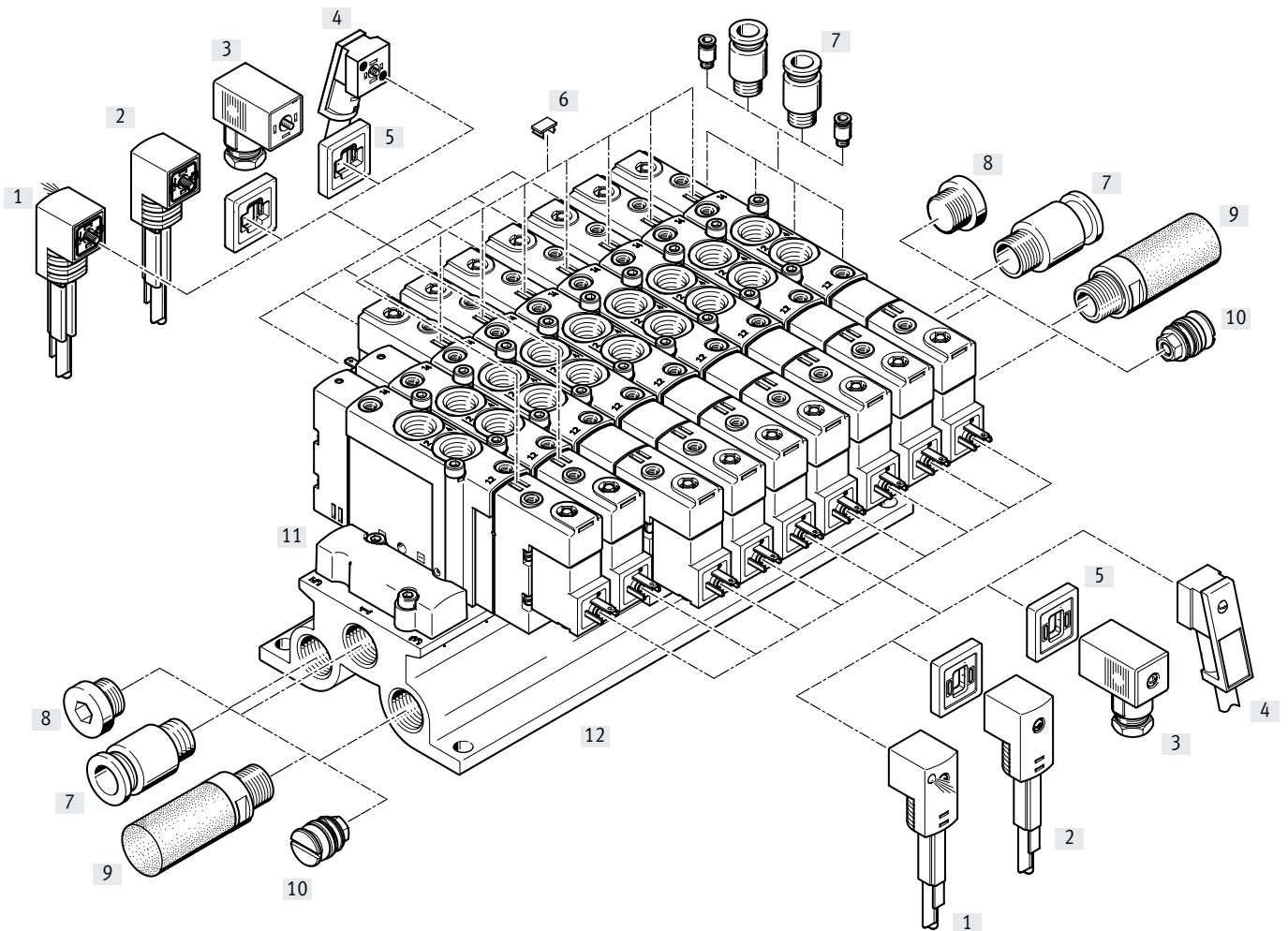

## Accessories – Mounting on manifold block

	Type	Description	→ Page/Internet	
[1]	Plug socket with cable	KMEB-1...	Cable sheath PVC, 24 V DC, with signal status indication	86
[2]	Plug socket with cable	KMEB-1...	Cable sheath PVC, to 240 V, without signal status indication	86
[3]	Plug socket	MSSD-EB...	Without signal status indication	86
[4]	Plug socket with cable	KMEB-2...	Cable sheath PUR	86
[5]	Illuminating seal	MEB-LD...	For 12 ... 24 V DC and 0 ... 230 V AC	86
[6]	Inscription label	IBS-6x10	–	86
[7]	Push-in fittings	QS...	For tubing	qs
[8]	Blanking plug	B...	–	86
[9]	Silencer	U... or UC...	For mounting in exhaust ports	86
[10]	Separator for pressure zones	VABD..., PRSV...	For fitting on the manifold block	86
[11]	Cover plate	CPE18-RP	For fitting on vacant positions for 5/2- and 5/3-way valves	68
		CPE18-RP3	For fitting on vacant positions for 3/2-way valves	70
[12]	Manifold block	CPE18-PRS...	For 5/2-way and 5/3-way valves	68
		CPE18-3/2-PRS...	For 3/2-way valves	70

## System overview

### Manifold assembly with modular manifold blocks

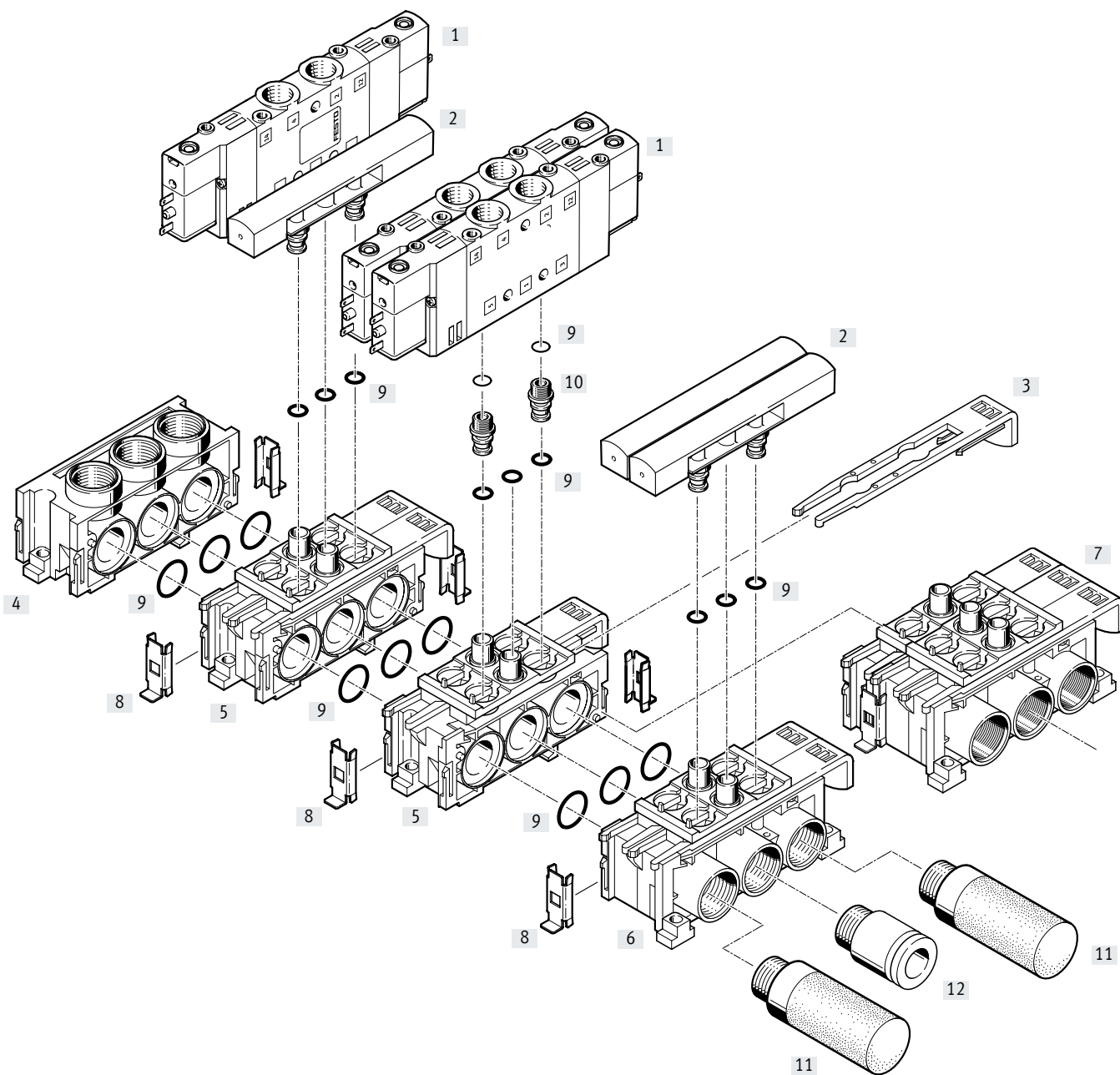

#### Accessories – Manifold assembly

	Type	Description	→ Page/Internet
[1]	Solenoid valve CPE...	–	–
[2]	Cover plate CPE...-RP	For sealing vacant positions	–
[3]	Spool –	For mounting the valve	–
[4]	End plate CPE...-PRS-EP	–	–
[5]	Extension block CPE...-PRSE-2	For 2 valves	–
[6]	Manifold block CPE...-PRSG-2	For 2 valves	–
[7]	Manifold block CPE...-PRSG-3	For 3 valves	–
[8]	Connecting component –	For connecting the blocks	–
[9]	Seal –	Included in the scope of delivery	–
[10]	Fitting –	Included in the scope of delivery	–
[11]	Silencer U or UC	–	–
[12]	Push-in fitting QS...	For tubing	–

## Type codes

001		Series
CPE		Solenoid valve, Compact Performance
002		Width
10		10 mm
003		Nominal operating voltage
M1		24 V DC
004		Electrical connection
BH		Plug pattern ZC
CH		Plug M8x1
005		Valve function
5L		5/2-way valve, monostable
5J		5/2-way valve, bistable
3GL		3/2-way valve, normally closed
3OL		3/2-way valve, normally open
5/3G		5/3-way valve, mid-position closed
5/3E		5/3-way valve, mid-position exhausted
5/3B		5/3-way valve, mid-position pressurised



006		Pilot air
		Internal
S		External
007		Pneumatic connection
M5		M5
M7		M7
QS-4		Push-in connector 4 mm
QS-6		Push-in connector 6 mm
008		Generation
		None
B		Series B

## Datasheet

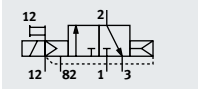
Function  
 3/2G, 3/2O,  
 5/2-way single solenoid  
 5/2-way double pilot valve  
 5/3G, 5/3B, 5/3E



e.g. 3/2-way valve with external pilot air supply, normally closed

-  - Width 10 mm
-  - Flow rate  
180 ... 400 l/min
-  - Voltage  
24 V DC

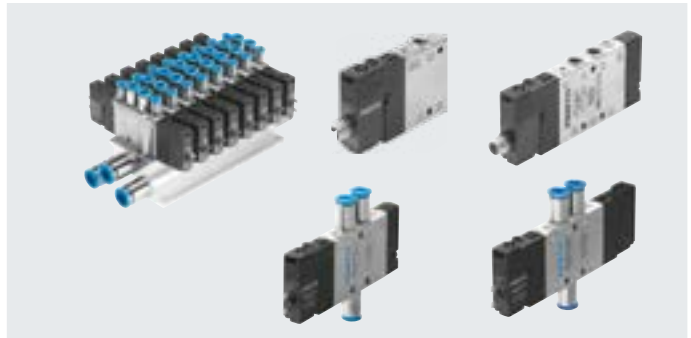

General technical data			3/2		5/2		5/3		
Valve function			G <sup>1)</sup>	O <sup>2)</sup>	-	-	G <sup>1)</sup>	B <sup>2)</sup>	E <sup>3)</sup>
Normal position			Monostable		Bistable		Monostable		
Stable position			Yes		-		No		
Pneumatic spring reset			No		-		Yes		
Mechanical spring reset			Piston spool						
Design			Soft						
Sealing principle			Positive overlap						
Overlap			Electrical						
Actuation type			Piloted						
Type of control			Internal or external						
Pilot air supply			-		Reversible with external pilot air supply				
Flow direction			-		Can be throttled				
Exhaust function			Non-detenting, detenting via accessory						
Manual override			Via through-holes						
Type of mounting			Any						
Mounting position			Threaded connection: M5, M7 QS connection: Ø 4 or Ø 6 mm						
Pneumatic connection	1, 2, 4		Threaded connection: M7						
	3, 5		Threaded connection: M3, QS connection: Ø 3 mm						
	12, 14		Threaded connection: M3						
	82, 84								
Nominal width		[mm]	4						
Standard nominal flow rate	M5	[l/min]	190	180					
	M7	[l/min]	400	350		300	250		
	QS4	[l/min]	190	180					
	QS6	[l/min]	300	350	320	300	250		
Switching time	On/Off	[ms]	1 4/14		1 6/20		-		
	Reverse	[ms]	-		8		-		
Duty cycle		[%]	100						
Width		[mm]	10						
Corrosion resistance class CRC <sup>4)</sup>			2						

1) G = normally closed  
 2) O, B = normally open  
 3) E = normally exhausted  
 4) More information: [www.festo.com/x/topic/kbk](http://www.festo.com/x/topic/kbk)

## Datasheet

Operating and environmental conditions			
Valve function		3/2	5/2-way, single solenoid   5/2-way, double solenoid   5/3
Operating medium		Compressed air to ISO 8573-1:2010 [7:4:4]	
Pilot medium		Compressed air to ISO 8573-1:2010 [7:4:4]	
Note on the operating/pilot medium		Lubricated operation possible (in which case lubricated operation will always be required)	
Operating pressure	Internal pilot air supply	[MPa]	0.25 ... 0.8   0.3 ... 0.8
		[bar]	2.5 ... 8   3 ... 8
	External pilot air supply	[MPa]	-0.09 ... 1
		[bar]	-0.9 ... 10
Pilot pressure	[MPa]	0.25 ... 0.8   0.3 ... 0.8	
	[bar]	2.5 ... 8   3 ... 8	
Ambient temperature	[°C]	-5 ... +50	
Temperature of medium	[°C]	-5 ... +50	
Certification for solenoid valves		c UL us - Recognized (OL)	
Maritime classification <sup>1)</sup>		See certificate	
Certificate-issuing authority		DNV-TAA000032X UL MH19482	

1) Additional information: [www.festo.com/sp](http://www.festo.com/sp) → Certificates.

Electrical data			
Operating voltage	M1BH, M1CH	[V DC]	24 +10/-15%
Power consumption	M1BH, M1CH	[W]	1.28
Degree of protection with plug socket		IP65 to IEC 60529 M1CH: IP65/IP67 to IEC 60529	
Max. tightening torque of plug socket M8x1	M1CH	[Nm]	0.4

## Materials

Sectional view

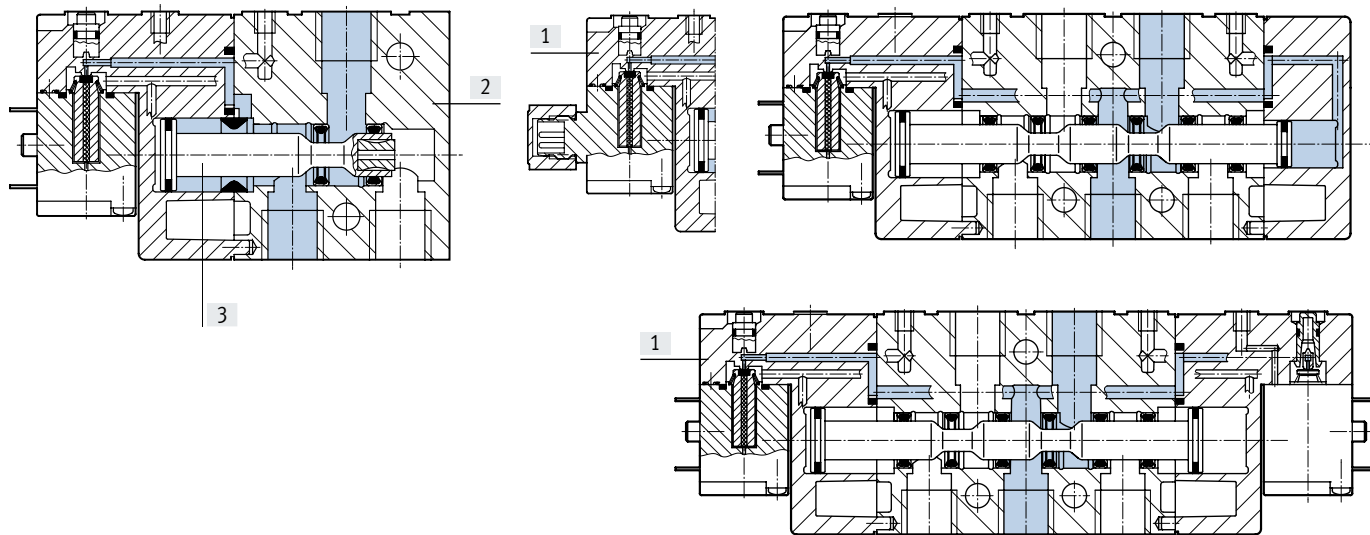

[1] Cover	PA
[2] Housing	Die-cast aluminium
[3] Piston spool	Steel
- Seals	NBR
Note on materials	RoHS-compliant

Datasheet

Dimensions – 3/2-way valve

Download CAD data → [www.festo.com](http://www.festo.com)

CPE10-...-3...-M7

CPE10-...-3...-M5

CPE10-...-3...-QS-4

CPE10-...-3...-QS-6

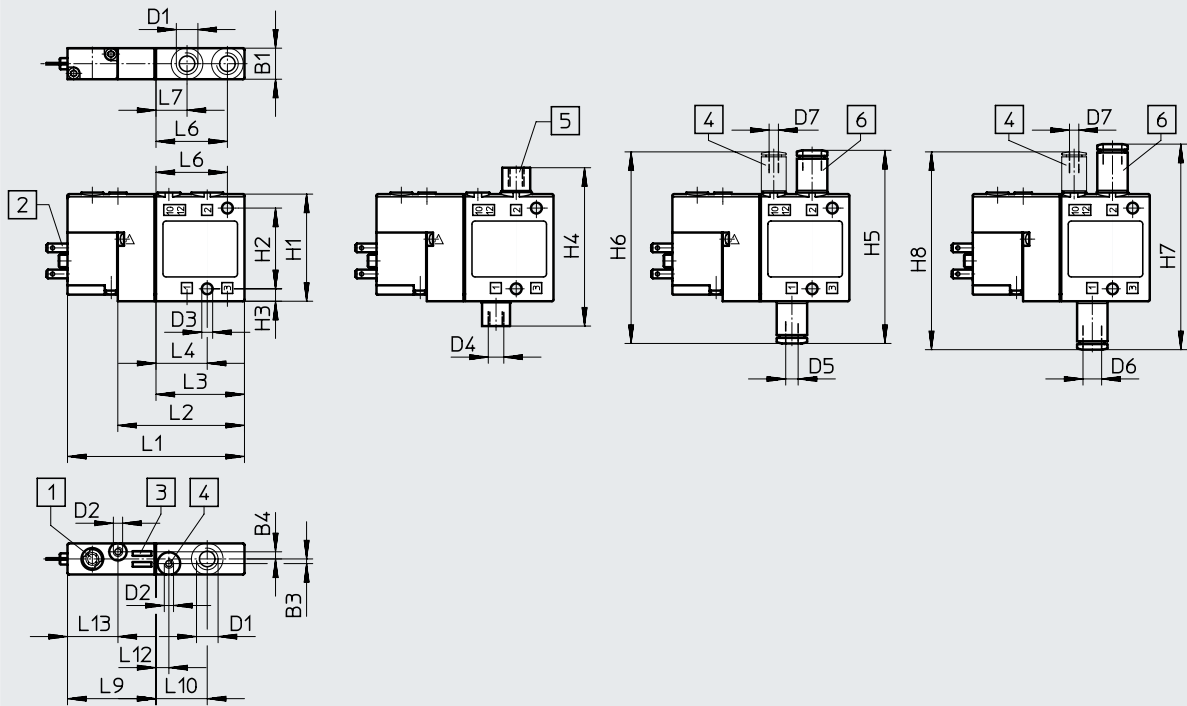

- [1] Manual override, push to reset
- [2] Plug pins, plug pattern ZC
- [3] Space for inscription labels
- [4] Port 10/12 for external pilot air
- [5] M7 to M5 reducer
- [6] QS push-in fitting

Type	B1	B3	B4	D1	D2	D3 ø	D4	D5 ø	D6 ø	D7 ø	H1	H2	H3	H4	H5	H6	H7	H8
CPE10-M1BH-3...	10	1.5	2.3	M7	M3	3.5	M5	4	6	3	35	26	4	51	62.2	61.7	66.2	63.7

Type	L1	L2	L3	L4	L6	L7	L9	L10	L12	L13
CPE10-M1BH-3...	57	40.8	28.5	16.5	23	10	28.5	16.5	4.2	16.3

Datasheet

Dimensions – 5/2-way single solenoid valve

Download CAD data → [www.festo.com](http://www.festo.com)

CPE10-...-5L...-M7

CPE10-...-5L...-M5

CPE10-...-5L...-QS-4

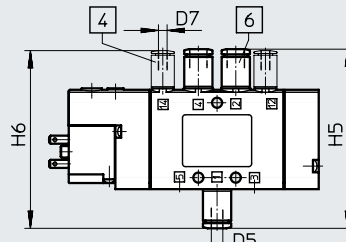
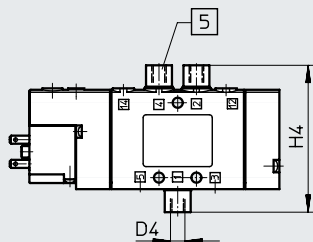
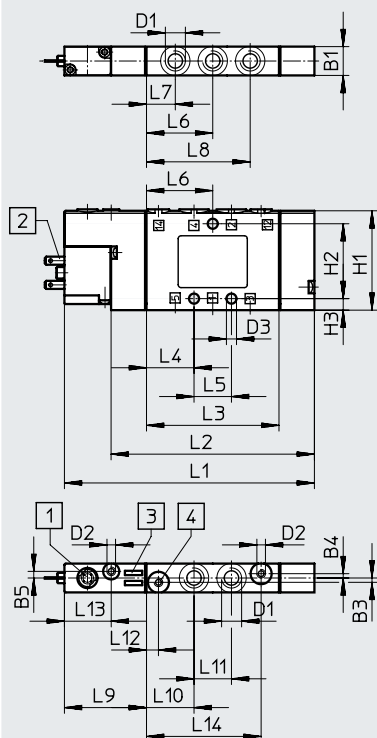

CPE10-...-5L...-QS-6

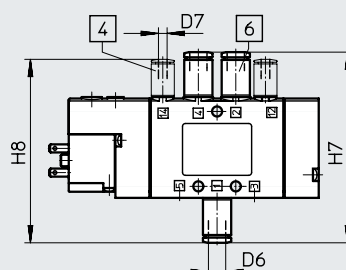

- [1] Manual override, push to reset
- [2] Plug pins, plug pattern ZC
- [3] Space for inscription labels
- [4] Port 12/14 for external pilot air
- [5] M7 to M5 reducer
- [6] QS push-in fitting

Type	B1	B3	B4	B5	D1	D2	D3∅	D4	D5 ∅	D6∅	D7∅	H1	H2	H3	H4	H5	H6	H7	H8
CPE10-M1BH-5L...	10	1.5	1.5	2.3	M7	M3	3.5	M5	4	6	3	35	26	4	51	62.2	61.7	66.2	63.7

Type	L1	L2	L3	L4	L5	L6	L7	L8	L9	L10	L11	L12	L13	L14
CPE10-M1BH-5L...	86.8	70.6	46	16.5	13	23	10	36	28.5	16.5	13	4.2	16.3	39.8

Datasheet

Dimensions – 5/2-way double pilot valve and 5/3-way valve

Download CAD data → [www.festo.com](http://www.festo.com)

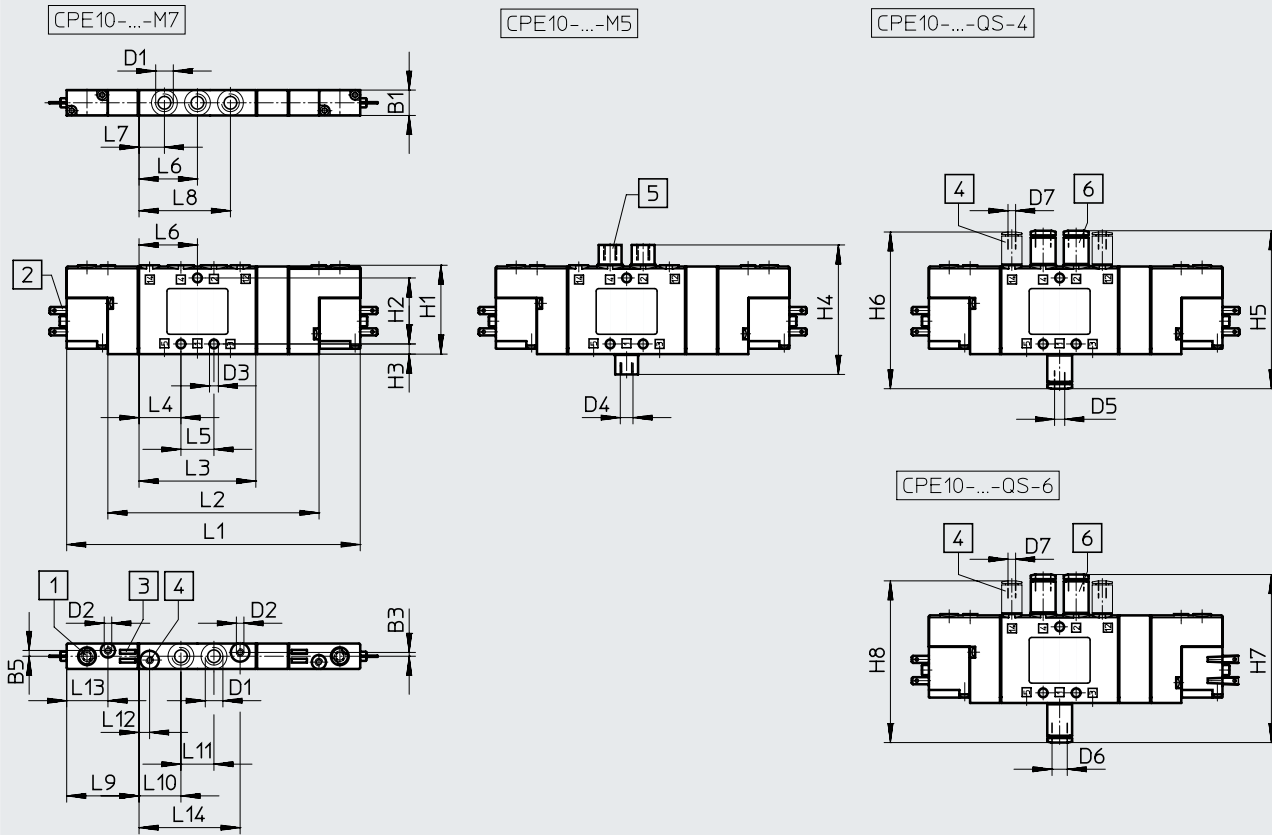

- [1] Manual override, push to reset
- [2] Plug pins, plug pattern ZC
- [3] Space for inscription labels
- [4] Port 12/14 for external pilot air
- [5] M7 to M5 reducer
- [6] QS push-in fitting

Type	B1	B3	B5	D1	D2	D3 ∅	D4	D5 ∅	D6 ∅	D7 ∅	H1	H2	H3	H4	H5	H6	H7	H8
CPE-10-...-5]	10	1.5	2.3	M7	M3	3.5	M5	4	6	3	35	26	4	51	62.2	61.7	66.2	63.7
CPE-10-...-5/3																		

Type	L1	L2	L3	L4	L5	L6	L7	L8	L9	L10	L11	L12	L13	L14
CPE-10-...-5]	103	70.6	46	16.5	13	23	10	36	28.5	16.5	13	4.2	16.3	39.8
CPE-10-...-5/3	115.6	83.2												



Datasheet

Dimensions – Solenoid valves with round plug M8x1

Download CAD data → [www.festo.com](http://www.festo.com)

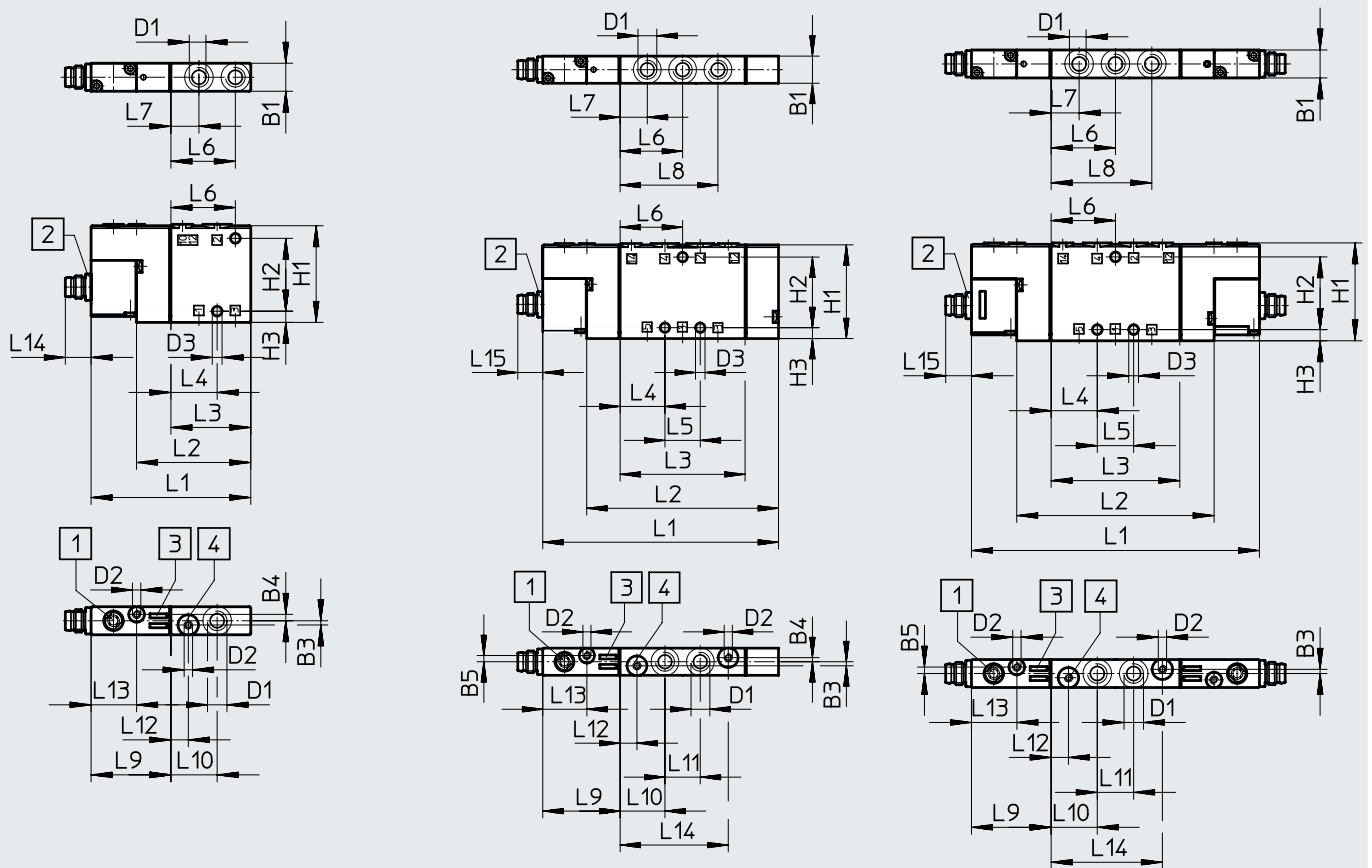

- [1] Manual override, push to reset
- [2] Plug M8x1
- [3] Space for inscription labels
- [4] Port 12/14 for external pilot air

Type	B1	B3	B4	B5	D1	D2	D3 ∅	H1	H2	H3
CPE-10-M1CH-3...	10	1.5	2.3	–	M7	M3	3.5	35	26	4
CPE-10-M1CH-5L...			1.5	2.3						
CPE-10-M1CH-5J...			–	–						

Type	L1	L2	L3	L4	L5	L6	L7	L8	L9	L10	L11	L12	L13	L14	L15
CPE-10-M1CH-3...	57	40.8	28.5	16.5	–	23	10	–	28.5	16.5	–	6.2	16.3	9.2	–
CPE-10-M1CH-5L...	86.8	70.6	46	–	13	–	–	36	–	–	13	–	–	39.82	9.2
CPE-10-M1CH-5J...	103	–	–	–	–	–	–	–	–	–	–	–	–	–	–

Ordering data

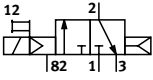
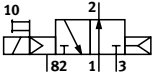
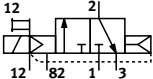
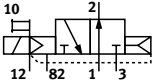
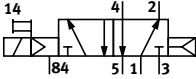
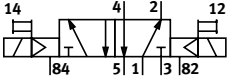
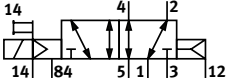
Ordering data Circuit symbol	Pilot air supply	Electrical connection	Operating voltage	Pneumatic connection	Weight [g]	Part no.	Type
<b>3/2-way valve, normally closed</b>							
	Internal	Plug pins, plug pattern ZC	24 V DC	M5	–	196845	CPE10-M1BH-3GL-M5
				M7	40	196915	CPE10-M1BH-3GL-M7
				QS-4	–	196846	CPE10-M1BH-3GL-QS-4
				QS-6	–	196847	CPE10-M1BH-3GL-QS-6
				M7	40	550233	CPE10-M1CH-3GL-M7
<b>3/2-way valve, normally open</b>							
	Internal	Plug pins, plug pattern ZC	24 V DC	M5	–	196851	CPE10-M1BH-3OL-M5
				M7	40	196917	CPE10-M1BH-3OL-M7
				QS-4	–	196852	CPE10-M1BH-3OL-QS-4
				QS-6	–	196853	CPE10-M1BH-3OL-QS-6
				M7	40	550235	CPE10-M1CH-3OL-M7
<b>3/2-way valve, normally closed</b>							
	External	Plug pins, plug pattern ZC	24 V DC	M5	–	196848	CPE10-M1BH-3GLS-M5
				M7	40	196916	CPE10-M1BH-3GLS-M7
				QS-4	–	196849	CPE10-M1BH-3GLS-QS-4
				QS-6	–	196850	CPE10-M1BH-3GLS-QS-6
				M7	40	550234	CPE10-M1CH-3GLS-M7
<b>3/2-way valve, normally open</b>							
	External	Plug pins, plug pattern ZC	24 V DC	M5	–	196854	CPE10-M1BH-3OLS-M5
				M7	40	196918	CPE10-M1BH-3OLS-M7
				QS-4	–	196855	CPE10-M1BH-3OLS-QS-4
				QS-6	–	196856	CPE10-M1BH-3OLS-QS-6
				M7	40	550236	CPE10-M1CH-3OLS-M7
<b>5/2-way valve, single solenoid</b>							
	Internal	Plug pins, plug pattern ZC	24 V DC	M5	–	196881	CPE10-M1BH-5L-M5
				M7	56	196927	CPE10-M1BH-5L-M7
				QS-4	–	196882	CPE10-M1BH-5L-QS-4
				QS-6	–	196883	CPE10-M1BH-5L-QS-6
				M7	56	550223	CPE10-M1CH-5L-M7
<b>5/2-way double pilot valve</b>							
	Internal	Plug pins, plug pattern ZC	24 V DC	M5	–	196875	CPE10-M1BH-5J-M5
				M7	68	196925	CPE10-M1BH-5J-M7
				QS-4	–	196876	CPE10-M1BH-5J-QS-4
				QS-6	–	196877	CPE10-M1BH-5J-QS-6
				M7	68	550225	CPE10-M1CH-5J-M7
<b>5/2-way valve, single solenoid</b>							
	External	Plug pins, plug pattern ZC	24 V DC	M5	–	196884	CPE10-M1BH-5LS-M5
				M7	56	196928	CPE10-M1BH-5LS-M7
				QS-4	–	196885	CPE10-M1BH-5LS-QS-4
				QS-6	–	196886	CPE10-M1BH-5LS-QS-6
				M7	56	550224	CPE10-M1CH-5LS-M7

## Ordering data

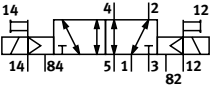
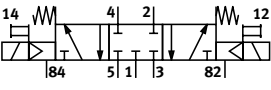
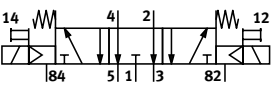
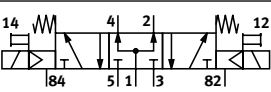
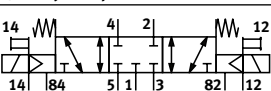
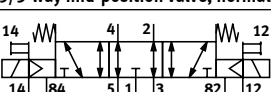
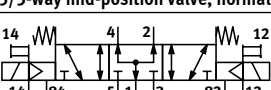
Ordering data Circuit symbol	Pilot air supply	Electrical connection	Operating voltage	Pneumatic connection	Weight [g]	Part no.	Type
<b>5/2-way double pilot valve</b>							
	External	Plug pins, plug pattern ZC	24 V DC	M5	–	196878	CPE10-M1BH-5JS-M5
				M7	68	196926	CPE10-M1BH-5JS-M7
				QS-4	–	196879	CPE10-M1BH-5JS-QS-4
				QS-6	–	196880	CPE10-M1BH-5JS-QS-6
		Plug M8x1		M7	68	550226	CPE10-M1CH-5JS-M7
<b>5/3-way mid-position valve, normally closed</b>							
	Internal	Plug pins, plug pattern ZC	24 V DC	M5	–	533159	CPE10-M1BH-5/3G-M5-B
				M7	68	533141	CPE10-M1BH-5/3G-M7-B
				QS-4	–	533147	CPE10-M1BH-5/3G-QS-4
				QS-6	–	533153	CPE10-M1BH-5/3G-QS-6
		Plug M8x1		M7	68	550227	CPE10-M1CH-5/3G-M7
<b>5/3-way mid-position valve, normally exhausted</b>							
	Internal	Plug pins, plug pattern ZC	24 V DC	M5	–	533161	CPE10-M1BH-5/3E-M5-B
				M7	68	533143	CPE10-M1BH-5/3E-M7-B
				QS-4	–	533149	CPE10-M1BH-5/3E-QS-4-B
				QS-6	–	533155	CPE10-M1BH-5/3E-QS-6-B
		Plug M8x1		M7	68	550229	CPE10-M1CH-5/3E-M7
<b>5/3-way mid-position valve, normally open</b>							
	Internal	Plug pins, plug pattern ZC	24 V DC	M5	–	533163	CPE10-M1BH-5/3B-M5-B
				M7	68	533145	CPE10-M1BH-5/3B-M7-B
				QS-4	–	533151	CPE10-M1BH-5/3B-QS-4-B
				QS-6	–	533157	CPE10-M1BH-5/3B-QS-6-B
		Plug M8x1		M7	68	550231	CPE10-M1CH-5/3B-M7
<b>5/3-way mid-position valve, normally closed</b>							
	External	Plug pins, plug pattern ZC	24 V DC	M5	–	533160	CPE10-M1BH-5/3GS-M5-B
				M7	68	533142	CPE10-M1BH-5/3GS-M7-B
				QS-4	–	533148	CPE10-M1BH-5/3GS-QS-4-B
				QS-6	–	533154	CPE10-M1BH-5/3GS-QS-6-B
		Plug M8x1		M7	68	550228	CPE10-M1CH-5/3GS-M7
<b>5/3-way mid-position valve, normally exhausted</b>							
	External	Plug pins, plug pattern ZC	24 V DC	M5	–	533162	CPE10-M1BH-5/3ES-M5-B
				M7	68	533144	CPE10-M1BH-5/3ES-M7-B
				QS-4	–	533150	CPE10-M1BH-5/3ES-QS-4-B
				QS-6	–	533156	CPE10-M1BH-5/3ES-QS-6-B
		Plug M8x1		M7	68	550230	CPE10-M1CH-5/3ES-M7
<b>5/3-way mid-position valve, normally open</b>							
	External	Plug pins, plug pattern ZC	24 V DC	M5	–	533164	CPE10-M1BH-5/3BS-M5-B
				M7	68	533146	CPE10-M1BH-5/3BS-M7-B
				QS-4	–	533152	CPE10-M1BH-5/3BS-QS-4-B
				QS-6	–	533158	CPE10-M1BH-5/3BS-QS-6-B
		Plug M8x1		M7	68	550232	CPE10-M1CH-5/3BS-M7

## Datasheet – Manifold block

### Manifold block CPE...-PRS

Material:  
Wrought aluminium alloy

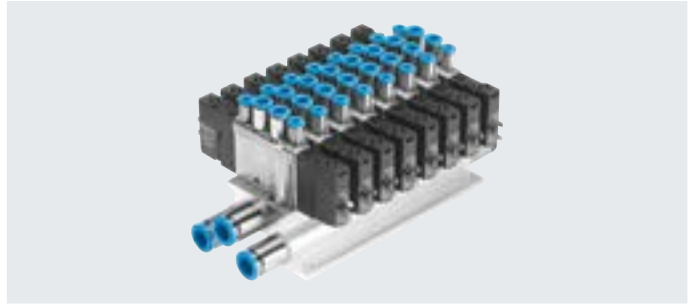

#### Dimensions – Fixed-grid manifold 5/2 and 5/3

Download CAD data → [www.festo.com](http://www.festo.com)

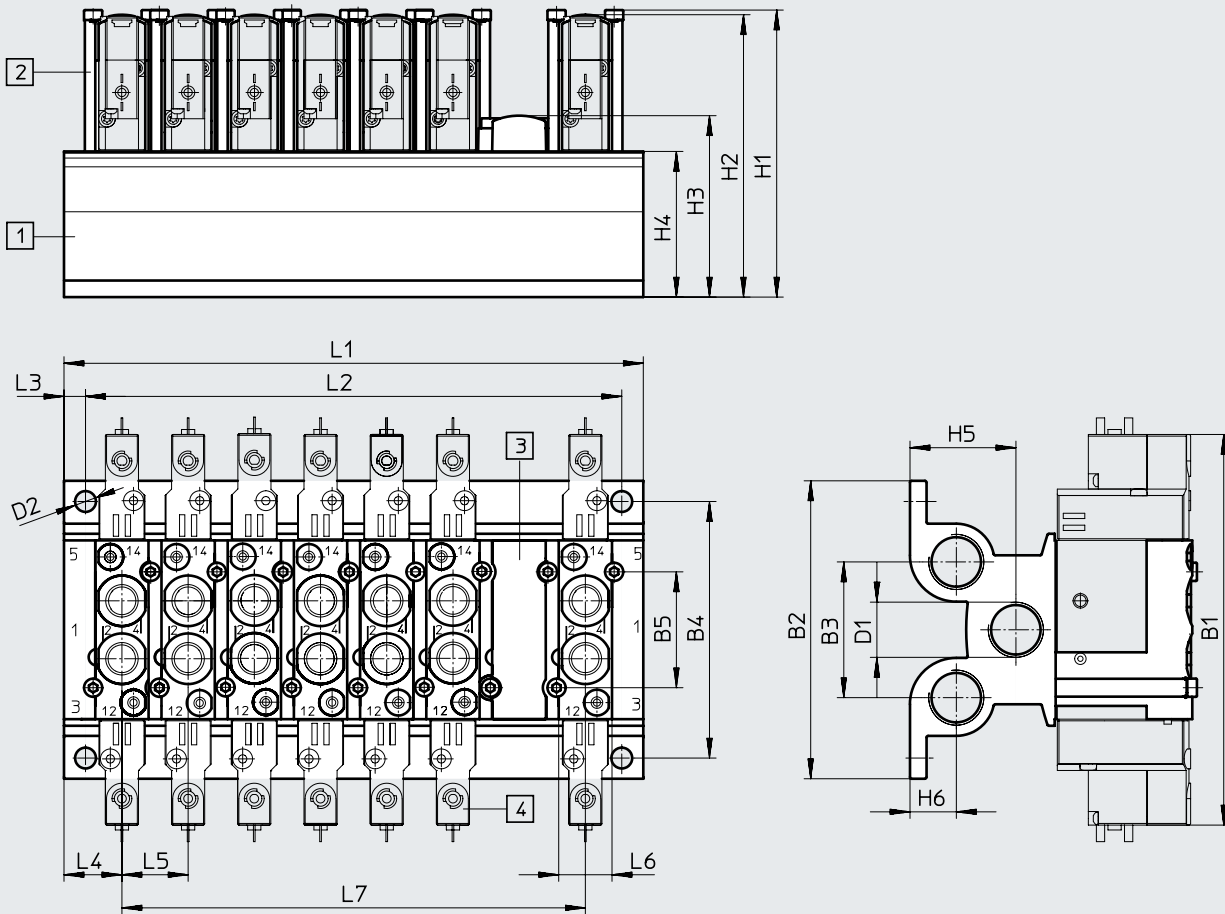

[1] Manifold block

[2] Retaining bracket

[3] Cover plate

[4] Valves

Type	B1	B2	B3	B4	B5	D1	D2 ∅	H1	H2	H3	H4	H5	H6
CPE10-PRS...	103	79	35	67.5	26	G1/4	5.3	72	69.5	44.8	34	23.5	11

  

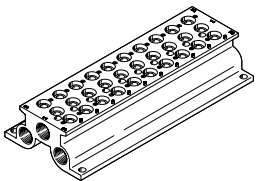

Type	L1		L2		L3	L4	L5	L6	L7	
CPE10-PRS...	28 + (n-1) x 16		L1 - 11 ± 0.1		5.5	14	16	13.4	(n-1) x 16	

## Ordering data – Fixed-grid manifold block

Ordering data	Valve positions	CRC <sup>1)</sup>	Max. tightening torque [Nm]	Weight [g]	Part no.	Type
<b>Manifold block for 5/2- and 5/3-way valves</b>						
	2	2	1.2	131	543821	CPE10-PRS-1/4-2
	3			179	543822	CPE10-PRS-1/4-3
	4			227	543823	CPE10-PRS-1/4-4
	5			275	543824	CPE10-PRS-1/4-5
	6			323	543825	CPE10-PRS-1/4-6
	7			371	543826	CPE10-PRS-1/4-7
	8			419	543827	CPE10-PRS-1/4-8
	9			467	543828	CPE10-PRS-1/4-9
	10			515	543829	CPE10-PRS-1/4-10

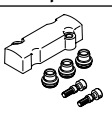
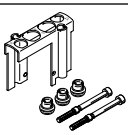
 1) More information: [www.festo.com/x/topic/kbk](http://www.festo.com/x/topic/kbk)

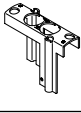
Ordering data	Material	Part no.	Type
<b>Cover plate for vacant position</b>			
	PA	544479	CPE10-RP
<b>Retaining bracket set</b>			
	Retaining bracket: high-alloy stainless steel Screws: galvanised steel Seals: NBR	544394	CPE10-H5-SET

Ordering data	Material	Part no.	Type
<b>Retaining bracket</b>			
	Retaining bracket: high-alloy stainless steel (packaging unit 50 pieces)	547045	CPE10-H5-50
<b>Screws</b>			
	Galvanised steel (packaging unit 100 pieces)	547048	M3X40-8.8-VS-100
<b>Seals</b>			
	NBR (packaging unit 150 pieces)	547051	CPV10-VI-P.M7-150

## Technical data – Fixed-grid manifold block

### Manifold block

For CPE10 3/2

### Material:

Wrought aluminium alloy

RoHS-compliant

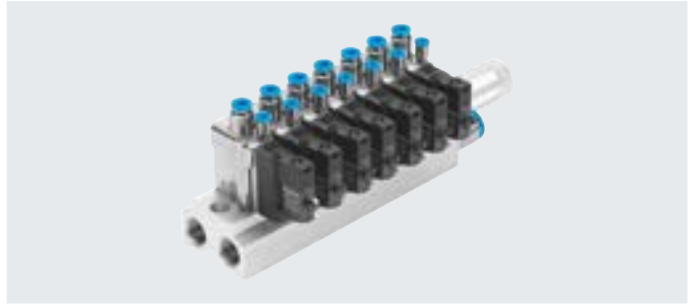

### Dimensions – Fixed-grid manifold block 3/2

Download CAD data → [www.festo.com](http://www.festo.com)

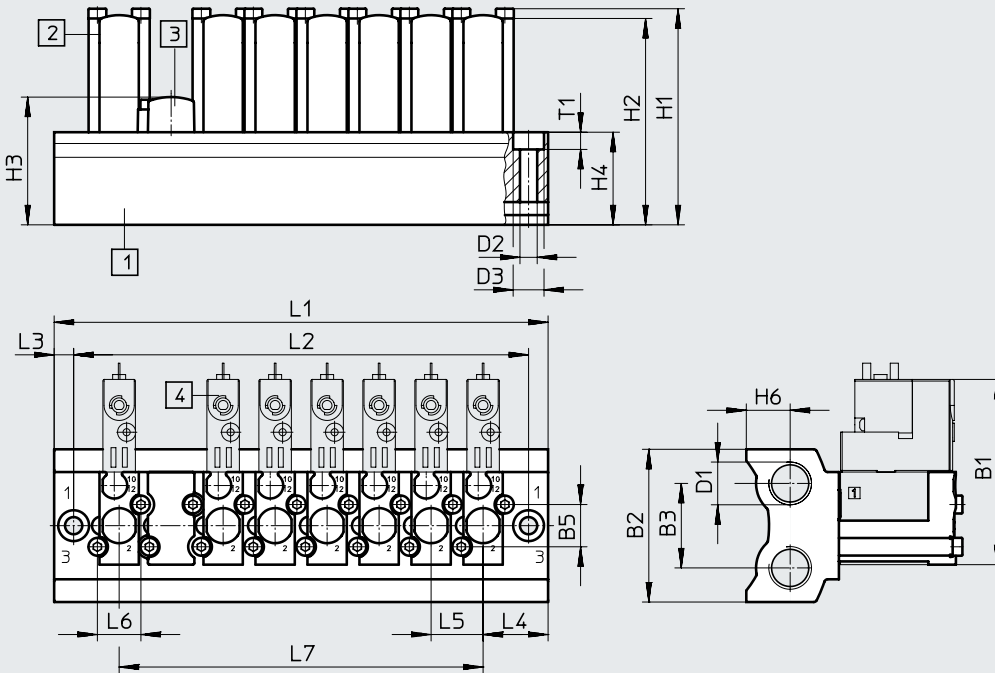

[1] Manifold block

[2] Retaining bracket

[3] Cover plate

[4] Valves

Type	B1	B2	B3	B5	D1	D2 ∅	D3 ∅	H1	H2	H3	H4	H6
CPE10-3/2-PRS...	57	47	26	13	G1/4	5.3	9.5	66.5	63.5	39.3	28.5	13.5

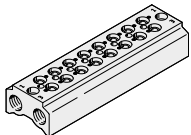

Type	L1	L2	L3	L4	L5	L6	L7	T1
CPE10-3/2-PRS...	40 + (n-1) x 16	28 + (n-1) x 16	6	20	16	13.4	(n-1) x 16	5.3

## Ordering data – Fixed-grid manifold block

Ordering data		Valve positions	CRC <sup>1)</sup>	Max. tightening torque for valve mounting [Nm]	Weight [g]	Part no.	Type
<b>Manifold block for 3/2-way valves</b>							
	2	2	1.2		128	550550	CPE10-3/2-PRS-1/4-2
	3				164	550551	CPE10-3/2-PRS-1/4-3
	4				201	550552	CPE10-3/2-PRS-1/4-4
	5				237	550553	CPE10-3/2-PRS-1/4-5
	6				274	550554	CPE10-3/2-PRS-1/4-6
	7				310	550555	CPE10-3/2-PRS-1/4-7
	8				347	550556	CPE10-3/2-PRS-1/4-8
	9				383	550557	CPE10-3/2-PRS-1/4-9
	10				420	550558	CPE10-3/2-PRS-1/4-10

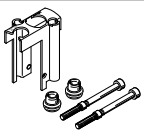
 1) More information: [www.festo.com/x/topic/kbk](http://www.festo.com/x/topic/kbk)

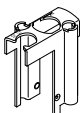
Ordering data		Material	Part no.	Type
<b>Cover plate</b>				
	PA RoHS-compliant		550580	CPE10-RP3
<b>Retaining bracket set</b>				
	Retaining bracket: high-alloy stainless steel Screws: galvanised steel Seals: NBR RoHS-compliant		550577	CPE10-H3-SET

Ordering data		Material	Part no.	Type
<b>Retaining bracket</b>				
	Retaining bracket: high-alloy stainless steel (packaging unit 50 pieces)		551490	CPE10-H3-50
<b>Screws</b>				
	Galvanised steel (packaging unit 100 pieces)		547048	M3X40-8.8-VS-100
<b>Seals</b>				
	NBR (packaging unit 150 pieces)		547051	CPV10-VI-P.M7-150

Technical data – Modular manifold

**Modular manifold block**

For CPE18 5/2 and 5/3

Material:  
Reinforced PA

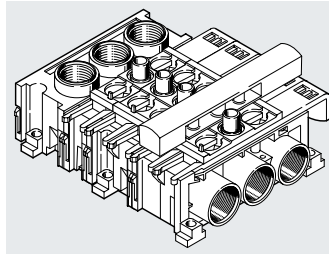

**Dimensions – Modular manifold block**

Download CAD data → [www.festo.com](http://www.festo.com)

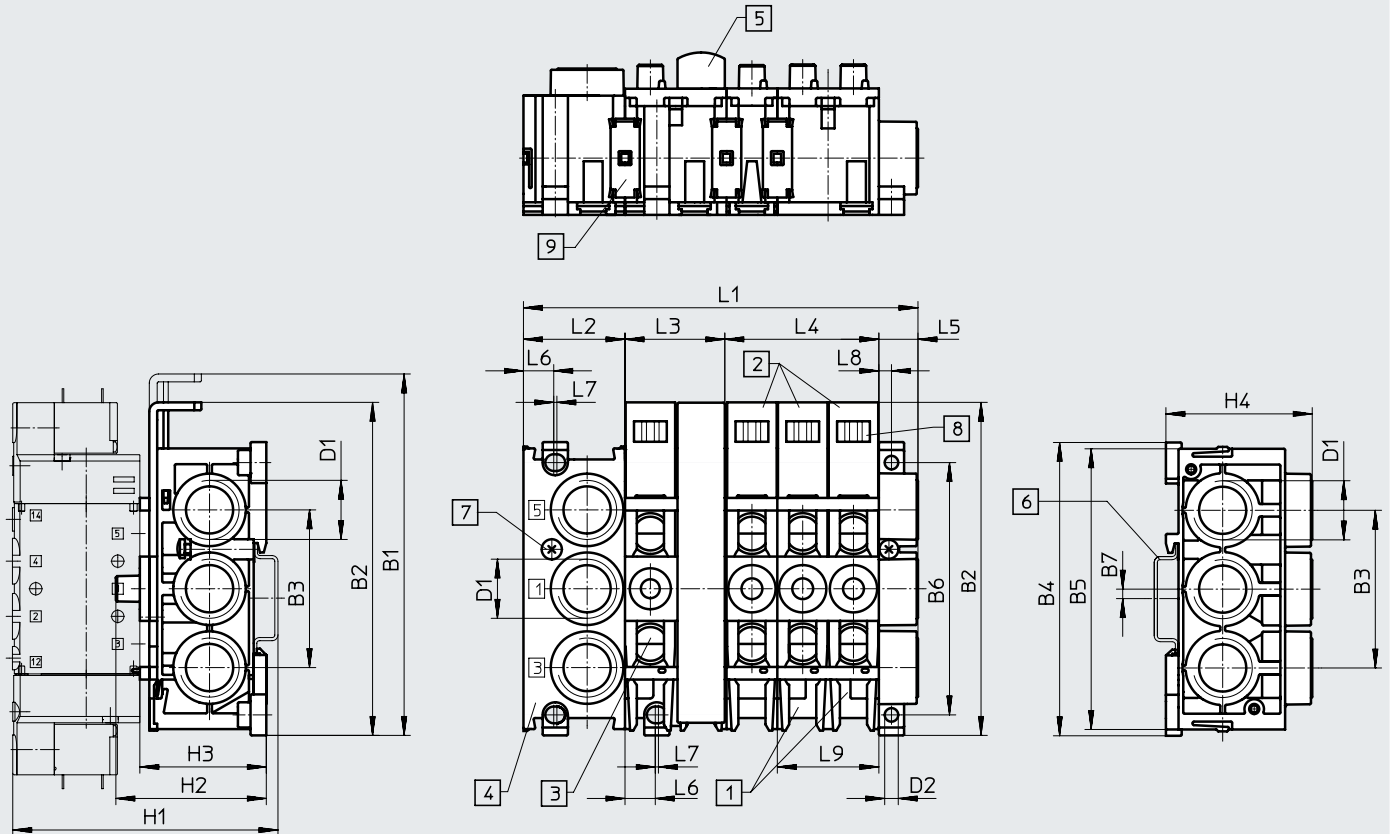

- [1] Manifold block CPE...-PRSG...-2 for 2 valves
- [2] Manifold block CPE...-PRSG...-3 for 3 valves
- [3] Expansion block CPE...-PRSE...-2 for 2 valves
- [4] End block CPE...-PRS-EP
- [5] Cover plate CPE...-PRSB
- [6] H-rail to EN 50002 for mounting
- [7] Clamping screw for H-rail
- [8] Location for inscription label type IBS 6 x 10
- [9] Connecting component

Size	B1	B2	B3	B4	B5	B6	B7	D1	D2 ∅	H1	H2	H3	H4
CPE10	93.5	87	37	73	71	60	7	G1/4	3.3	~72	~40	~34	37

Size	L1 <sup>1)</sup>			L2	L3	L4	L5	L6	L7	L8	L9
CPE10	24+(nx12)+11.4			24	24	36	11.4	9.6	-	3.2	24

1) n = number of valve positions



## Technical data – Modular manifold

Combination options Number of valve positions	One pressure zone	Two pressure zones	
		Variant 1	Variant 2
2	1x CPE...-PRSG-2	–	–
3	1x CPE...-PRSG-3	–	–
4	1x CPE...-PRSGO-2 1x CPE...-PRSE-2	1x CPE...-PRSG-2 1x CPE...-PRSEO-2 1x CPE...-PRS-EP	–
5	1x CPE...-PRSGO-3 1x CPE...-PRSE-2	1x CPE...-PRSG-3 1x CPE...-PRSEO-2 1x CPE...-PRS-EP	–
6	1x CPE...-PRSGO-2 1x CPE...-PRSEO-2 1x CPE...-PRSE-2	1x CPE...-PRSG-2 2x CPE...-PRSEO-2 1x CPE...-PRS-EP	1x CPE...-PRSGO-2 1x CPE...-PRSE-2 1x CPE...-PRSEO-2 1x CPE...-PRS-EP
7	1x CPE...-PRSGO-3 2x CPE...-PRSEO-2 1x CPE...-PRS-EP	1x CPE...-PRSG-3 2x CPE...-PRSEO-2 1x CPE...-PRS-EP	1x CPE...-PRSGO-3 1x CPE...-PRSE-2 1x CPE...-PRSEO-2 1x CPE...-PRS-EP
8	1x CPE...-PRSGO-2 3x CPE...-PRSEO-2 1x CPE...-PRS-EP	1x CPE...-PRSG-2 3x CPE...-PRSEO-2 1x CPE...-PRS-EP	1x CPE...-PRSGO-2 1x CPE...-PRSE-2 2x CPE...-PRSEO-2 1x CPE...-PRS-EP
9	1x CPE...-PRSGO-3 3x CPE...-PRSEO-2 1x CPE...-PRS-EP	1x CPE...-PRSG-3 3x CPE...-PRSEO-2 1x CPE...-PRS-EP	1x CPE...-PRSGO-3 1x CPE...-PRSE-2 2x CPE...-PRSEO-2 1x CPE...-PRS-EP
10	1x CPE...-PRSGO-2 4x CPE...-PRSEO-2 1x CPE...-PRS-EP	1x CPE...-PRSG-2 4x CPE...-PRSEO-2 1x CPE...-PRS-EP	1x CPE...-PRSGO-2 1x CPE...-PRSE-2 3x CPE...-PRSEO-2 1x CPE...-PRS-EP
11	1x CPE...-PRSGO-3 4x CPE...-PRSEO-2 1x CPE...-PRS-EP	1x CPE...-PRSG-3 4x CPE...-PRSEO-2 1x CPE...-PRS-EP	1x CPE...-PRSGO-3 1x CPE...-PRSE-2 3x CPE...-PRSEO-2 1x CPE...-PRS-EP
12	1x CPE...-PRSGO-2 5x CPE...-PRSEO-2 1x CPE...-PRS-EP	1x CPE...-PRSG-2 5x CPE...-PRSEO-2 1x CPE...-PRS-EP	1x CPE...-PRSGO-2 1x CPE...-PRSE-2 4x CPE...-PRSEO-2 1x CPE...-PRS-EP

 **Note**

Each air supply can support a maximum of 6 valve positions. Use valve manifold blocks only in combination with 5/2- and 5/3-way valves.

## Type codes

001	Series
CPE	Solenoid valve, Compact Performance

002	Width
14	14 mm

003	Nominal operating voltage
M1	24 V DC

004	Electrical connection
BH	Plug pattern ZC
CH	Plug M8x1

005	Valve function
5L	5/2-way valve, monostable
5J	5/2-way valve, bistable
3GL	3/2-way valve, normally closed
3OL	3/2-way valve, normally open
5/3G	5/3-way valve, mid-position closed
5/3E	5/3-way valve, mid-position exhausted
5/3B	5/3-way valve, mid-position pressurised

006	Pilot air
	Internal
S	External

007	Pneumatic connection
1/8	G1/8
QS-6	Push-in connector 6 mm
QS-8	Push-in connector 8 mm



## Datasheet

### Function

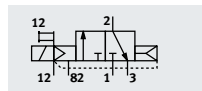
3/2G, 3/2O,  
5/2-way single solenoid  
5/2-way double pilot valve  
5/3G, 5/3B, 5/3E



e.g. 3/2-way valve with external pilot air supply,  
normally closed

-  - Width 14 mm
-  - Flow rate  
370 ... 900 l/min
-  - Voltage  
24 V DC



General technical data			3/2		5/2		5/3		
Valve function			3/2		5/2		5/3		
Normal position			G <sup>1)</sup>	O <sup>2)</sup>	-	-	G <sup>1)</sup>	B <sup>2)</sup>	E <sup>3)</sup>
Stable position			Monostable			Bistable		Monostable	
Pneumatic spring reset			Yes			-		No	
Mechanical spring reset			No			-		Yes	
Design			Piston spool						
Sealing principle			Soft						
Overlap			Positive overlap						
Actuation type			Electrical						
Type of control			Piloted						
Pilot air supply			Internal or external						
Flow direction			-		Reversible with external pilot air supply				
Exhaust function			-		Can be throttled				
Manual override			Non-detenting, detenting via accessory						
Type of mounting			Via through-holes						
Mounting position			Any						
Pneumatic connection	1, 2, 4		Threaded connection: G1/8 QS connection: $\varnothing$ 6 or $\varnothing$ 8 mm						
	3, 5		Threaded connection: G1/8						
	12, 14		Threaded connection: M3, QS connection: $\varnothing$ 3 mm						
	82, 84		Threaded connection: M3						
Nominal width		[mm]	6						
Standard nominal flow rate	G1/8	[l/min]	900		800		750		700
Standard nominal flow rate	QS6	[l/min]	510		400		410		370
Standard nominal flow rate	QS8	[l/min]	810		680		720		650 570
Switching time on/off		[ms]	1 6/27		2 4/32		-		2 0/42
Changeover time		[ms]	-		-		12		-
Duty cycle		[%]	100						
Width		[mm]	14						
Corrosion resistance class CRC <sup>4)</sup>			2						

1) G = normally closed

2) O, B = normally open

3) E = normally exhausted

4) More information: [www.festo.com/x/topic/kbk](http://www.festo.com/x/topic/kbk)

## Datasheet

Operating and environmental conditions				
Valve function			3/2	5/2-way, single solenoid   5/2-way, double solenoid   5/3
Operating medium	Compressed air to ISO 8573-1:2010 [7:4:4]			
Pilot medium	Compressed air to ISO 8573-1:2010 [7:4:4]			
Note on the operating/pilot medium	Lubricated operation possible (in which case lubricated operation will always be required)			
Operating pressure	Internal pilot air supply	[MPa]	0.25 ... 0.8	0.3 ... 0.8   0.2 ... 0.8   0.3 ... 0.8
		[bar]	2.5 ... 8	3 ... 8   2 ... 8   3 ... 8
	External pilot air supply	[MPa]	-0.09 ... 1	
		[bar]	-0.9 ... 10	
Pilot pressure	[MPa]	0.25 ... 0.8	0.3 ... 0.8   0.2 ... 0.8   0.3 ... 0.8	
	[bar]	2.5 ... 8	3 ... 8   2 ... 8   3 ... 8	
Ambient temperature	[°C]	-5 ... +50		
Temperature of medium	[°C]	-5 ... +50		
Certification for solenoid valves	c UL us - Recognized (OL)			
Maritime classification <sup>1)</sup>	See certificate			
Certificate-issuing authority	DNV-TAA000032X UL MH19482			

1) Additional information: [www.festo.com/sp](http://www.festo.com/sp) → Certificates.

Electrical data				
Operating voltage	M1BH, M1CH	[V DC]	24 +10/-15%	
Power consumption	M1BH, M1CH	[W]	1.28	
Degree of protection with plug socket			IP65 to IEC 60529 M1CH: IP65/IP67 to IEC 60529	
Max. tightening torque of plug socket M8x1	M1CH	[Nm]	0.4	

## Materials

Sectional view

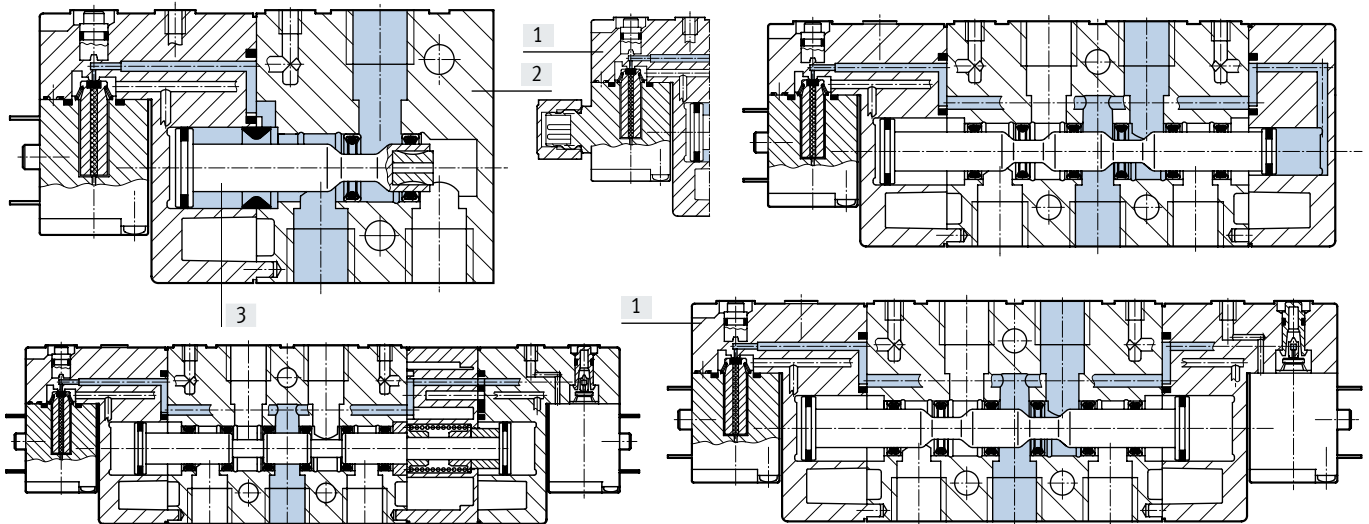

[1] Cover	PA
[2] Housing	Die-cast aluminium
[3] Piston spool	Steel
- Seals	NBR
Note on materials	RoHS-compliant

Datasheet

Dimensions – 3/2-way valve

Download CAD data → [www.festo.com](http://www.festo.com)

CPE14-...-1/8

CPE14-...-QS-6

CPE14-...-QS-8

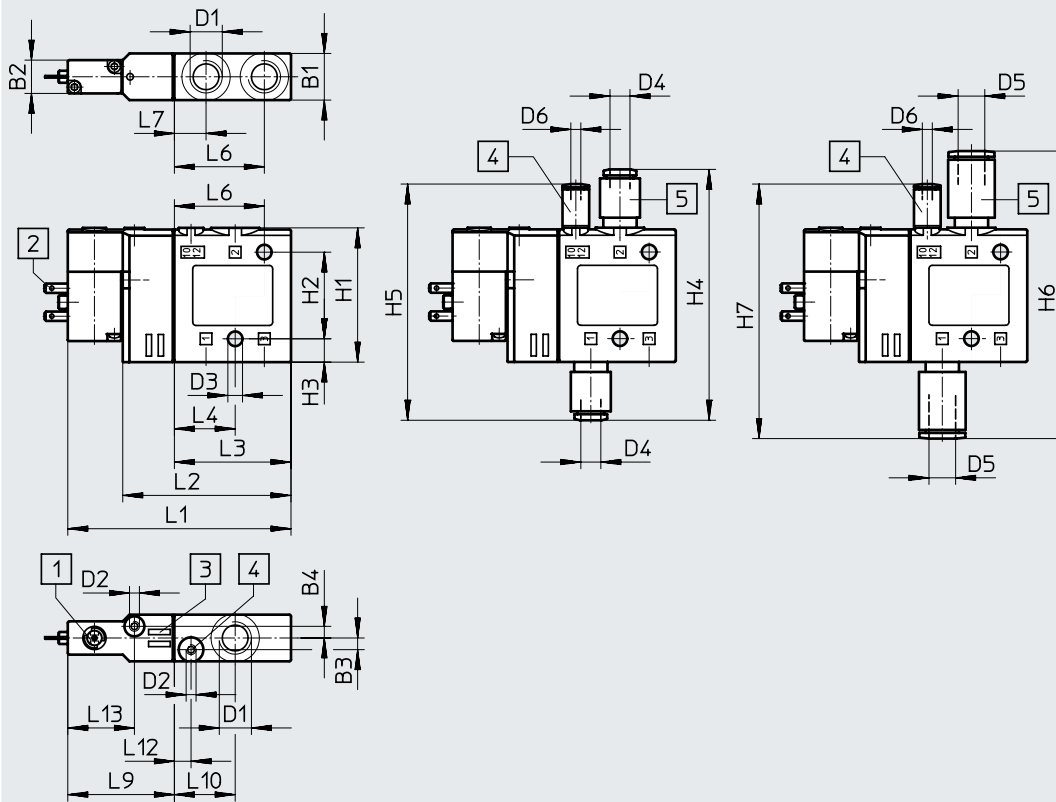

- [1] Manual override
- [2] Plug pins, plug pattern ZC
- [3] Space for inscription labels
- [4] Port 10/12 for external pilot air supply
- [5] QS push-in fitting

Type	B1	B2	B3	B4	D1	D2	D3 ø	D4 ø	D5 ø	D6 ø	H1	H2	H3	H4	H5	H6	H7
CPE14-M1BH-3...	14	10	3.5	3.5	G1/8	M3	4.4	6	8	3	40.3	26	7	75.3	70.9	86.3	76.4

Type	L1	L2	L3	L4	L6	L7	L9	L10	L12	L13
CPE14-M1BH-3...	67	50.5	35	18.3	27	9.5	32	18	5	20

Datasheet

Dimensions – 5/2-way single solenoid valve

Download CAD data → [www.festo.com](http://www.festo.com)

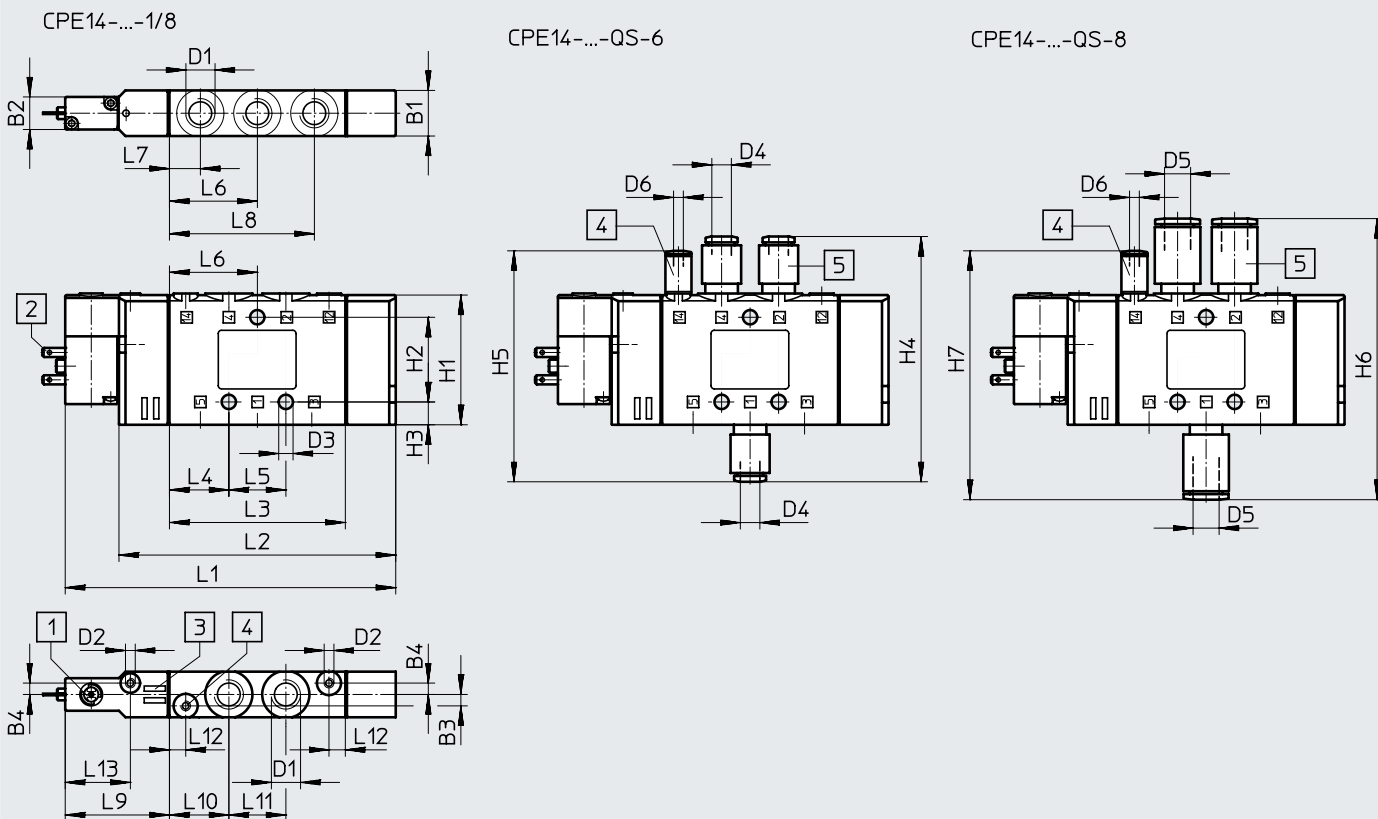

- [1] Manual override
- [2] Plug pins, plug pattern ZC
- [3] Space for inscription labels
- [4] Port 12/14 for external pilot air supply
- [5] QS push-in fitting

Type	B1	B2	B3	B4	D1	D2	D3 ø	D4 ø	D5 ø	D6 ø	H1	H2	H3	H4	H5	H6	H7
CPE14-M1BH-5L...	14	10	3.5	3.5	G1/8	M3	4.4	6	8	3	40.3	26	7	75.3	70.9	86.3	76.4

Type	L1	L2	L3	L4	L5	L6	L7	L8	L9	L10	L11	L12	L13
CPE14-M1BH-5L...	101.5	85	54	18.3	17.5	27	9.5	44.5	32	18.3	17.5	5	20

Datasheet

Dimensions – 5/2-way double solenoid valve

Download CAD data → [www.festo.com](http://www.festo.com)

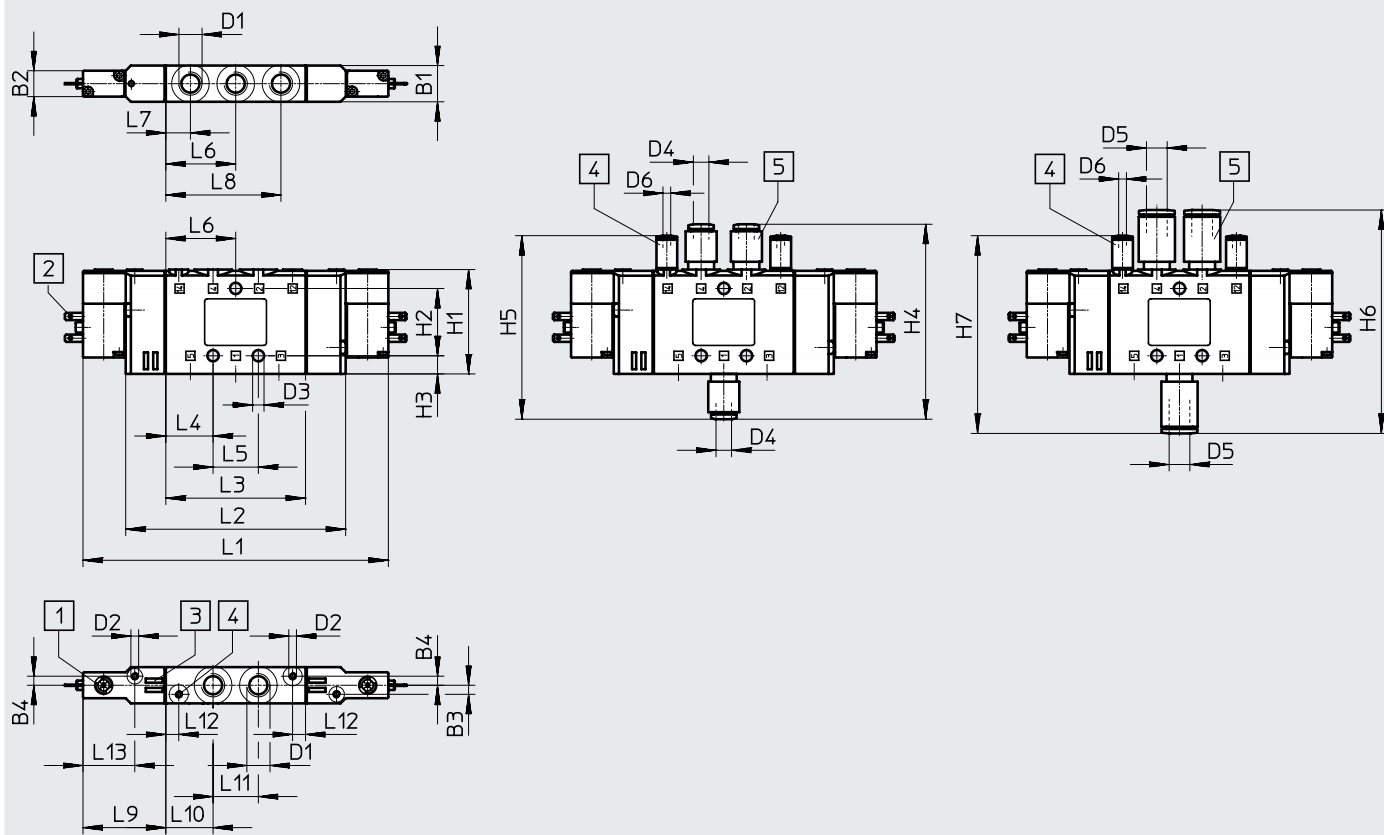

- [1] Manual override, push to reset
- [2] Plug pins, plug pattern ZC
- [3] Space for inscription labels
- [4] Port 12/14 for external pilot air supply
- [5] QS push-in fitting

Type	B1	B2	B3	B4	D1	D2	D3 ø	D4 ø	D5 ø	D6 ø	H1	H2	H3	H4	H5	H6	H7
CPE14-...-5J-1/8	14	10	3.5	3.5	G1/8	M3	4.4	6	8	3	40.3	26	7	75.3	70.9	86.3	76.4

Type	L1	L2	L3	L4	L5	L6	L7	L8	L9	L10	L11	L12	L13
CPE14-...-5J-1/8	118	85	54	18.3	17.5	27	9.5	44.5	32	18.3	17.5	5	20

Datasheet

Dimensions – 5/3-way valve

Download CAD data → [www.festo.com](http://www.festo.com)

CPE14-...-1/8

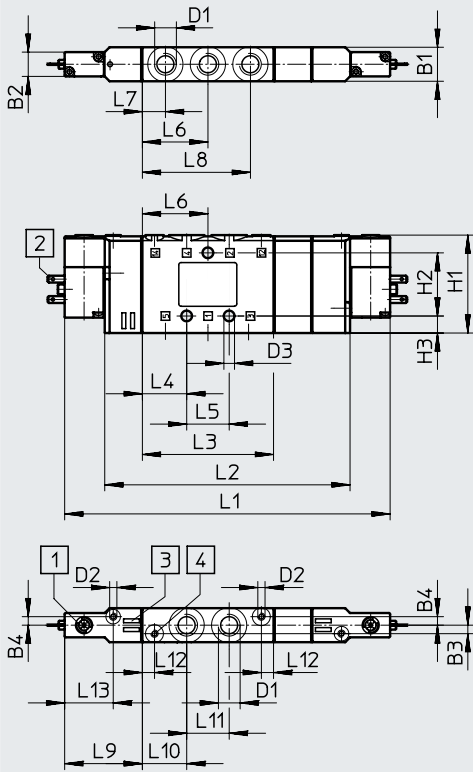

CPE14-...-QS-6

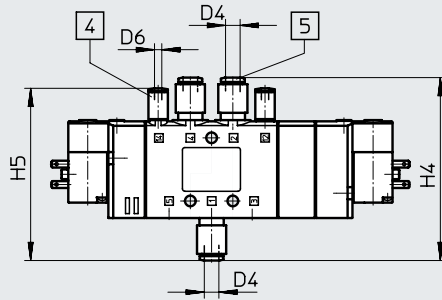

CPE14-...-QS-8

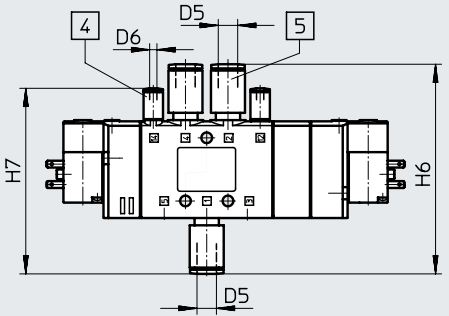

- [1] Manual override
- [2] Plug pins, plug pattern ZC
- [3] Space for inscription labels
- [4] Port 12/14 for external pilot air supply
- [5] QS push-in fitting

Type	B1	B2	B3	B4	D1	D2	D3 ø	D4 ø	D5 ø	D6 ø	H1	H2	H3	H4	H5	H6	H7
CPE14-M1BH...-5]	14	10	3.5	3.5	G1/8	M3	4.4	6	8	3	40.3	26	7	75.3	70.9	86.3	76.4
CPE14-M1BH...-5/3																	

Type	L1	L2	L3	L4	L5	L6	L7	L8	L9	L10	L11	L12	L13
CPE14-M1BH...-5]	118	85	46	18.3	17.5	27	9.5	44.5	32	18.3	17.5	5	20
CPE14-M1BH...-5/3	134	101											





Datasheet

Type	B1	B2	B3	B4	D1	D2	D3 ∅	H1	H2	H3
CPE14-M1CH-3...	14	10	3.5	3.5	G1/8	M3	4.4	40.3	26	7
CPE14-M1CH-5L...								40.4		
CPE14-M1CH-5J...								40.3		
CPE14-M1BH-5J										
CPE14-M1BH-5/3										

Type	L1	L2	L3	L4	L5	L6	L7	L8	L9	L10	L11	L12	L13	L14
CPE14-M1CH-3...	67	50.5	35	18.3	-	27	9.5	-	32	18.3	-	5	20	9.2
CPE14-M1CH-5L...	101.5	85	54		17.5			44.5			17.5			
CPE14-M1CH-5J...	118													
CPE14-M1BH-5J...														
CPE14-M1BH-5/3...	134	101												

## Ordering data

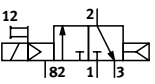
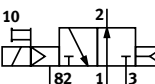
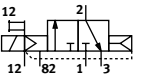
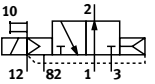
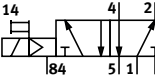
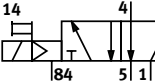
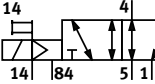
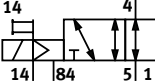
Ordering data							
Circuit symbol	Pilot air supply	Electrical connection	Operating voltage	Pneumatic connection	Weight [g]	Part no.	Type
<b>3/2-way valve, normally closed</b>							
	Internal	Plug pins, plug pattern ZC	24 V DC	G1/8	60	196929	CPE14-M1BH-3GL-1/8
				QS-6	–	196887	CPE14-M1BH-3GL-QS-6
		Plug M8x1	QS-8	–	196888	CPE14-M1BH-3GL-QS-8	
			G1/8	60	550247	CPE14-M1CH-3GL-1/8	
<b>3/2-way valve, normally open</b>							
	Internal	Plug pins, plug pattern ZC	24 V DC	G1/8	60	196931	CPE14-M1BH-3OL-1/8
				QS-6	–	196891	CPE14-M1BH-3OL-QS-6
		Plug M8x1	QS-8	–	196892	CPE14-M1BH-3OL-QS-8	
			G1/8	60	550249	CPE14-M1CH-3OL-1/8	
<b>3/2-way valve, normally closed</b>							
	External	Plug pins, plug pattern ZC	24 V DC	G1/8	60	196930	CPE14-M1BH-3GLS-1/8
				QS-6	–	196889	CPE14-M1BH-3GLS-QS-6
		Plug M8x1	QS-8	–	196890	CPE14-M1BH-3GLS-QS-8	
			G1/8	60	550248	CPE14-M1CH-3GLS-1/8	
<b>3/2-way valve, normally open</b>							
	External	Plug pins, plug pattern ZC	24 V DC	G1/8	60	196932	CPE14-M1BH-3OLS-1/8
				QS-6	–	196893	CPE14-M1BH-3OLS-QS-6
		Plug M8x1	QS-8	–	196894	CPE14-M1BH-3OLS-QS-8	
			G1/8	60	550250	CPE14-M1CH-3OLS-1/8	
<b>5/2-way valve, single solenoid</b>							
	Internal	Plug pins, plug pattern ZC	24 V DC	G1/8	95	196941	CPE14-M1BH-5L-1/8
				QS-6	–	196911	CPE14-M1BH-5L-QS-6
		Plug M8x1	QS-8	–	196912	CPE14-M1BH-5L-QS-8	
			G1/8	95	550237	CPE14-M1CH-5L-1/8	
<b>5/2-way double pilot valve</b>							
	Internal	Plug pins, plug pattern ZC	24 V DC	G1/8	115	196939	CPE14-M1BH-5J-1/8
				QS-6	–	196907	CPE14-M1BH-5J-QS-6
		Plug M8x1	QS-8	–	196908	CPE14-M1BH-5J-QS-8	
			G1/8	115	550239	CPE14-M1CH-5J-1/8	
<b>5/2-way valve, single solenoid</b>							
	External	Plug pins, plug pattern ZC	24 V DC	G1/8	95	196942	CPE14-M1BH-5LS-1/8
				QS-6	–	196913	CPE14-M1BH-5LS-QS-6
		Plug M8x1	QS-8	–	196914	CPE14-M1BH-5LS-QS-8	
			G1/8	95	550238	CPE14-M1CH-5LS-1/8	
<b>5/2-way double pilot valve</b>							
	External	Plug pins, plug pattern ZC	24 V DC	G1/8	115	196940	CPE14-M1BH-5JS-1/8
				QS-6	–	196909	CPE14-M1BH-5JS-QS-6
		Plug M8x1	QS-8	–	196910	CPE14-M1BH-5JS-QS-8	
			G1/8	115	550240	CPE14-M1CH-5JS-1/8	

## Ordering data

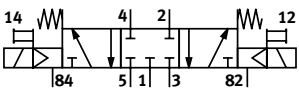
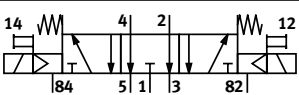
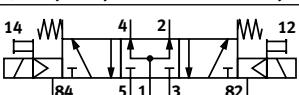
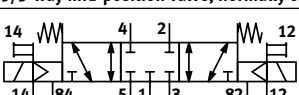
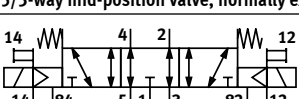
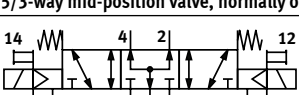
Ordering data Circuit symbol	Pilot air supply	Electrical connection	Operating voltage	Pneumatic connection	Weight [g]	Part no.	Type
<b>5/3-way mid-position valve, normally closed</b>							
	Internal	Plug pins, plug pattern ZC	24 V DC	G1/8	120	<b>196937</b>	CPE14-M1BH-5/3G-1/8
				QS-6	–	<b>196903</b>	CPE14-M1BH-5/3G-QS-6
				QS-8	–	<b>196904</b>	CPE14-M1BH-5/3G-QS-8
				Plug M8x1	G1/8	120	<b>550241</b>
<b>5/3-way mid-position valve, normally exhausted</b>							
	Internal	Plug pins, plug pattern ZC	24 V DC	G1/8	120	<b>196935</b>	CPE14-M1BH-5/3E-1/8
				QS-6	–	<b>196899</b>	CPE14-M1BH-5/3E-QS-6
				QS-8	–	<b>196900</b>	CPE14-M1BH-5/3E-QS-8
				Plug M8x1	G1/8	120	<b>550243</b>
<b>5/3-way mid-position valve, normally open</b>							
	Internal	Plug pins, plug pattern ZC	24 V DC	G1/8	120	<b>196933</b>	CPE14-M1BH-5/3B-1/8
				QS-6	–	<b>196895</b>	CPE14-M1BH-5/3B-QS-6
				QS-8	–	<b>196896</b>	CPE14-M1BH-5/3B-QS-8
				Plug M8x1	G1/8	120	<b>550245</b>
<b>5/3-way mid-position valve, normally closed</b>							
	External	Plug pins, plug pattern ZC	24 V DC	G1/8	120	<b>196938</b>	CPE14-M1BH-5/3GS-1/8
				QS-6	–	<b>196905</b>	CPE14-M1BH-5/3GS-QS-6
				QS-8	–	<b>196906</b>	CPE14-M1BH-5/3GS-QS-8
				Plug M8x1	G1/8	120	<b>550242</b>
<b>5/3-way mid-position valve, normally exhausted</b>							
	External	Plug pins, plug pattern ZC	24 V DC	G1/8	120	<b>196936</b>	CPE14-M1BH-5/3ES-1/8
				QS-6	–	<b>196901</b>	CPE14-M1BH-5/3ES-QS-6
				QS-8	–	<b>196902</b>	CPE14-M1BH-5/3ES-QS-8
				Plug M8x1	G1/8	120	<b>550244</b>
<b>5/3-way mid-position valve, normally open</b>							
	External	Plug pins, plug pattern ZC	24 V DC	G1/8	120	<b>196934</b>	CPE14-M1BH-5/3BS-1/8
				QS-6	–	<b>196897</b>	CPE14-M1BH-5/3BS-QS-6
				QS-8	–	<b>196898</b>	CPE14-M1BH-5/3BS-QS-8
				Plug M8x1	G1/8	120	<b>550246</b>

# Datasheet – Manifold block

## Manifold block CPE...-PRS

Material:  
Wrought aluminium alloy  
RoHS-compliant

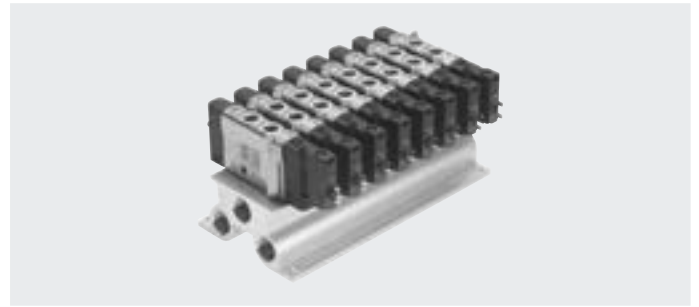

### Dimensions – Fixed-grid manifold 5/2 and 5/3

Download CAD data → [www.festo.com](http://www.festo.com)

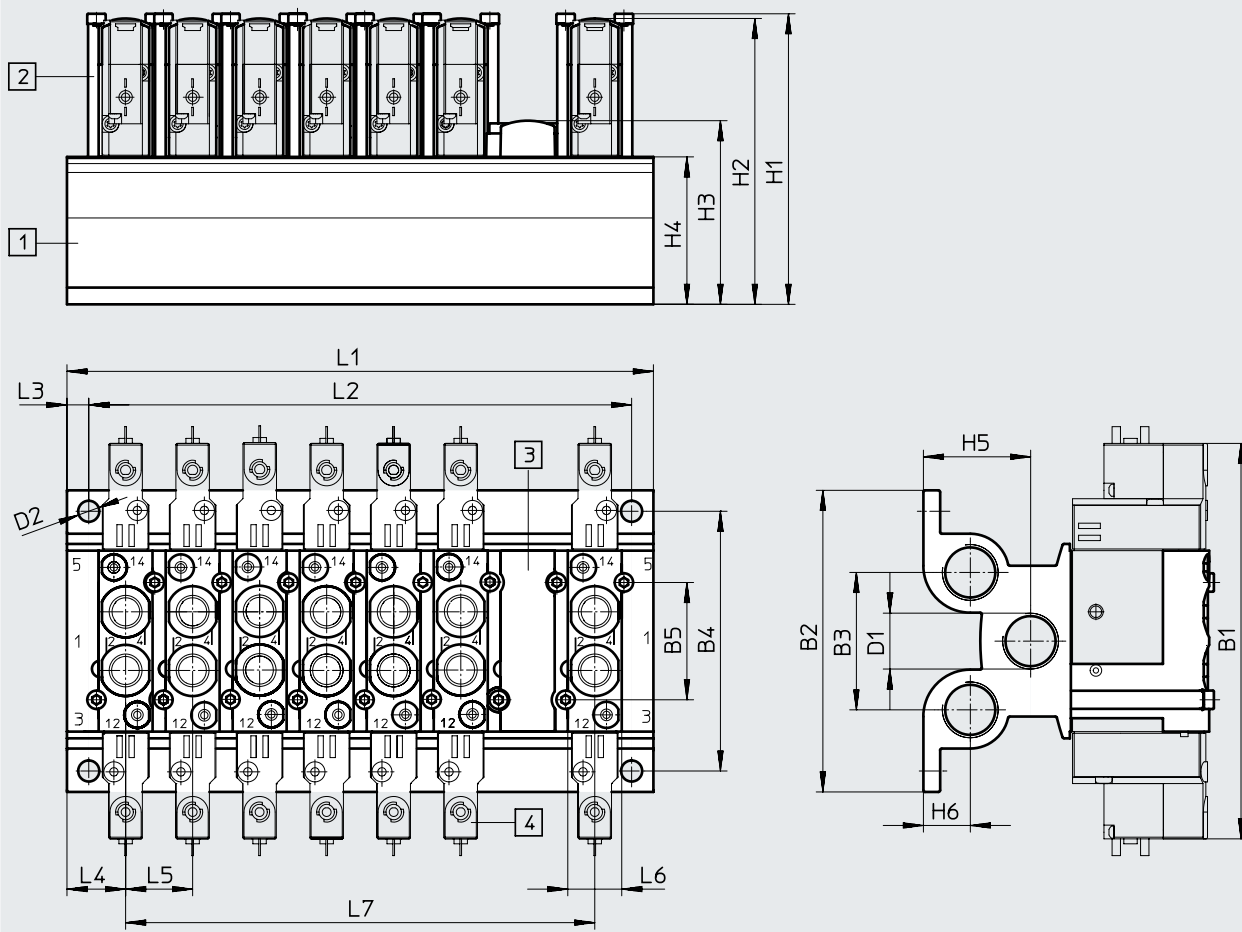

[1] Manifold block  
Grid dimension 16 mm

[2] Retaining bracket

[3] Cover plate

[4] Valves

Type	B1	B2	B3	B4	B5	D1	D2	H1	H2	H3	H4	H5	H6
CPE14-PRS...	118	90	41	77.5	35	G3/8	6.3	86.7	84.8	54.8	44	32	14

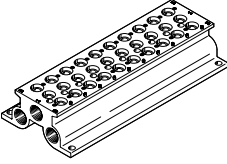

Type	L1	L2	L3	L4	L5	L6	L7
CPE14-PRS...	35 + (n-1) x 20	L1 - 13 ± 0.1	6.5	17.5	20	17.4	(n-1) x 20

## Ordering data – Fixed-grid manifold block

Ordering data	Valve positions	CRC <sup>1)</sup>	Max. tightening torque [Nm]	Weight [g]	Part no.	Type
<b>Manifold block for 5/2- and 5/3-way valves</b>						
	2	2	1.2	239	543830	CPE14-PRS-3/8-2
	3			326	543831	CPE14-PRS-3/8-3
	4			412	543832	CPE14-PRS-3/8-4
	5			498	543833	CPE14-PRS-3/8-5
	6			584	543834	CPE14-PRS-3/8-6
	7			671	543835	CPE14-PRS-3/8-7
	8			757	543836	CPE14-PRS-3/8-8
	9			843	543837	CPE14-PRS-3/8-9
	10			930	543838	CPE14-PRS-3/8-10

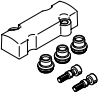
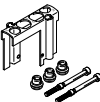
1) More information: [www.festo.com/x/topic/kbk](http://www.festo.com/x/topic/kbk)

Ordering data	Material	Part no.	Type
<b>Cover plate for vacant position</b>			
	PA	544480	CPE14-RP
<b>Retaining bracket set</b>			
	Retaining bracket: high-alloy stainless steel Screws: galvanised steel Seals: NBR	544395	CPE14-H5-SET

Ordering data	Material	Part no.	Type
<b>Retaining bracket</b>			
	Retaining bracket: high-alloy stainless steel (packaging unit 50 pieces)	547046	CPE14-H5-50
<b>Screws</b>			
	Galvanised steel (packaging unit 100 pieces)	547049	M3X45-8.8-VS-100
<b>Seals</b>			
	NBR (packaging unit 150 pieces)	547052	CPV14-VI-P.1/8-150

## Technical data – Fixed-grid manifold block

### Manifold block

For CPE14 3/2

Material:

Wrought aluminium alloy

RoHS-compliant

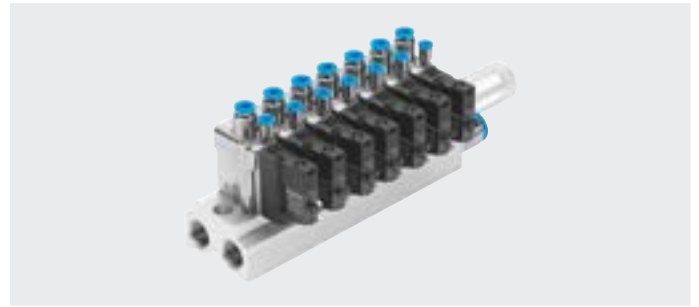

### Dimensions for fixed-grid manifold 3/2

Download CAD data → [www.festo.com](http://www.festo.com)

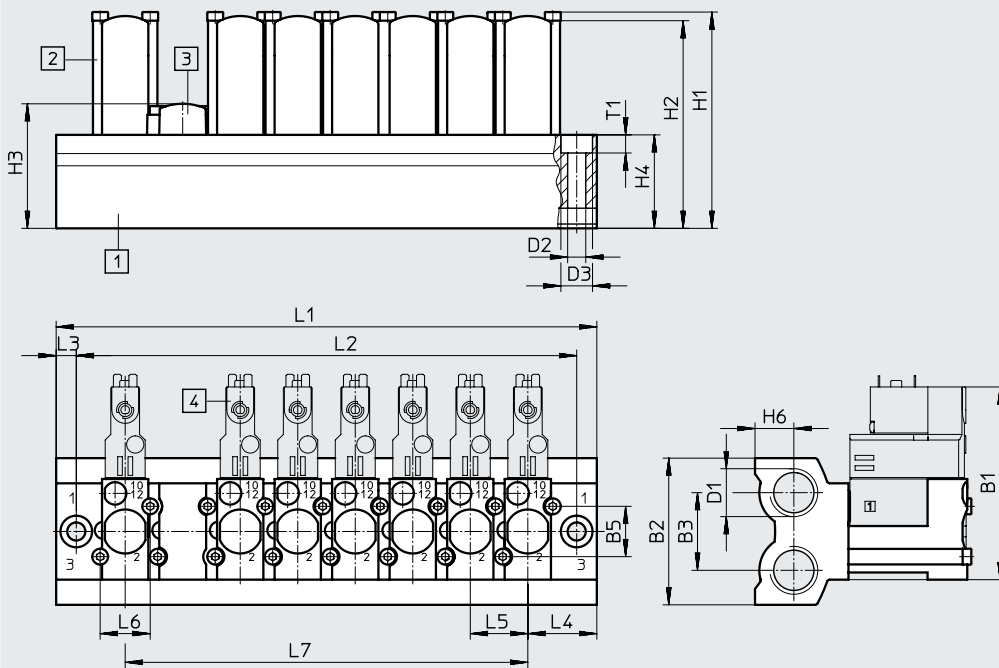

- [1] Manifold block
  - [2] Retaining bracket
  - [3] Cover plate
  - [4] Valves
- Grid dimension 20 mm

Type	B1	B2	B3	B5	D1	D2	D3	H1	H2	H3	H4	H6
CPE14-3/2-PRS...	67	51	27	17.5	G3/8	6.3	11	75.2	72.2	43.3	32.5	13.5

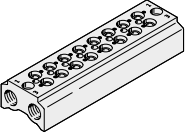

Type	L1	L2	L3	L4	L5	L6	L7	T1
CPE14-3/2-PRS...	$48 + (n-1) \times 20$	$34 + (n-1) \times 20$	7	24	20	17.4	$(n-1) \times 20$	6.3

Ordering data – Fixed-grid manifold block

Ordering data		Valve positions	CRC <sup>1)</sup>	Max. tightening torque for valve mounting [Nm]	Weight [g]	Part no.	Type
<b>Manifold block for 3/2-way valves</b>							
	2	2	1.2	176	550559	CPE14-3/2-PRS-3/8-2	
	3			228	550560	CPE14-3/2-PRS-3/8-3	
	4			280	550561	CPE14-3/2-PRS-3/8-4	
	5			332	550562	CPE14-3/2-PRS-3/8-5	
	6			384	550563	CPE14-3/2-PRS-3/8-6	
	7			436	550564	CPE14-3/2-PRS-3/8-7	
	8			488	550565	CPE14-3/2-PRS-3/8-8	
	9			540	550566	CPE14-3/2-PRS-3/8-9	
	10			592	550567	CPE14-3/2-PRS-3/8-10	

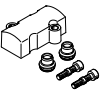
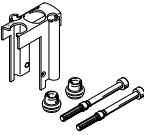
1) More information: [www.festo.com/x/topic/kbk](http://www.festo.com/x/topic/kbk)

Ordering data		Material	Part no.	Type
<b>Cover plate</b>				
		PA	550581	CPE14-RP3
<b>Retaining bracket set</b>				
		Retaining bracket: high-alloy stainless steel Screws: galvanised steel Seals: NBR	550578	CPE14-H3-SET

Ordering data		Material	Part no.	Type
<b>Retaining bracket</b>				
		Retaining bracket: high-alloy stainless steel (packaging unit 50 pieces)	551491	CPE14-H3-50
<b>Screws</b>				
		Galvanised steel (packaging unit 100 pieces)	547049	M3X45-8.8-VS-100
<b>Seals</b>				
		NBR (packaging unit 150 pieces)	547052	CPV14-VI-P.1/8-150



## Technical data – Modular manifold

### Modular manifold block

For CPE14 5/2 and 5/3

Material:  
Reinforced PA

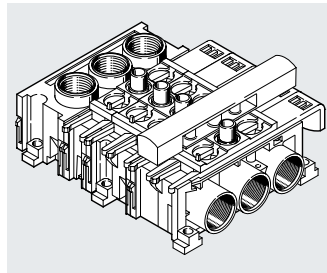

### Dimensions – Modular manifold block

Download CAD data → [www.festo.com](http://www.festo.com)

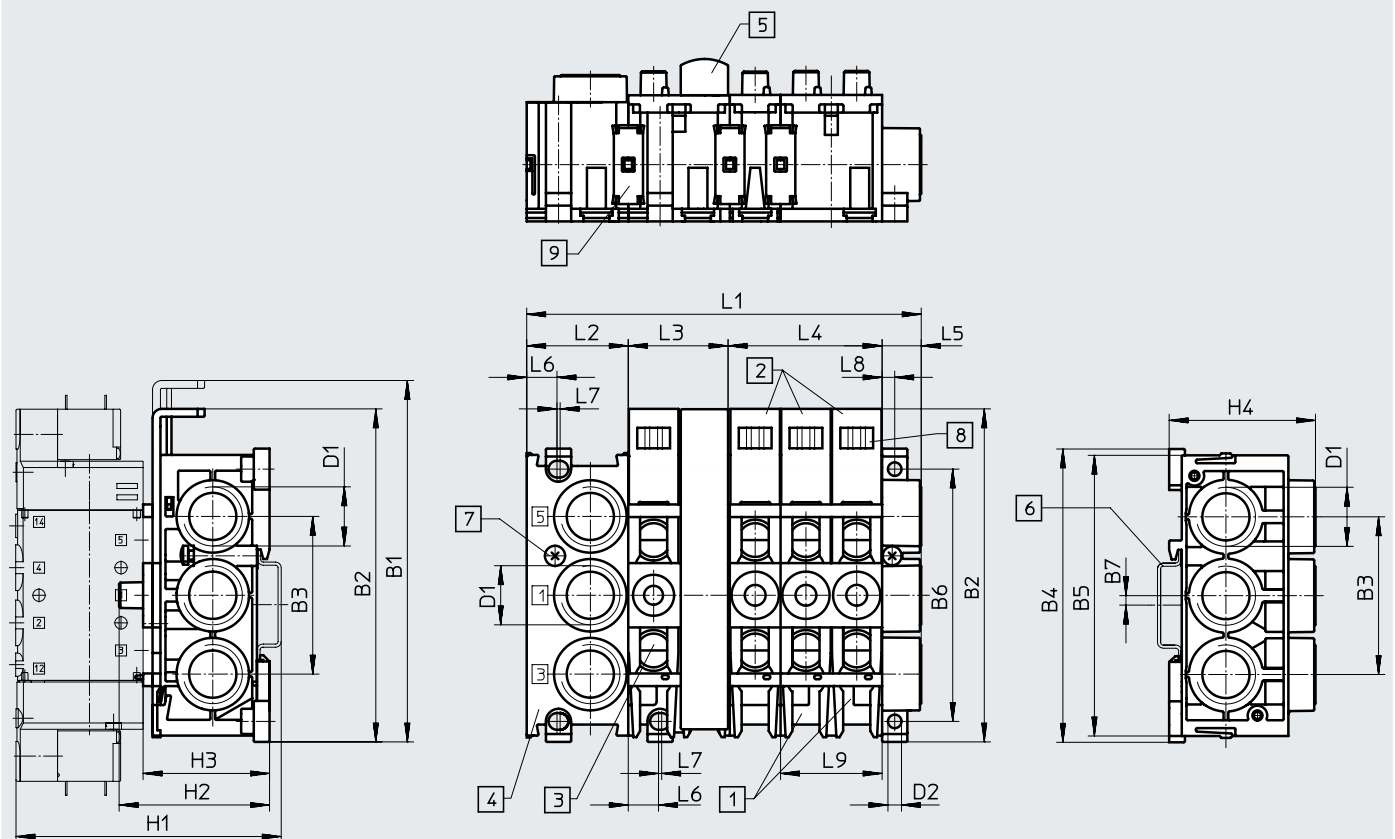

- [1] Manifold block  
CPE...-PRSG...-2 for  
2 valves
- [2] Manifold block  
CPE...-PRSG...-3 for  
3 valves
- [3] Expansion block  
CPE...-PRSE...-2 for 2 valves
- [4] End block CPE...-PRS-EP
- [5] Cover plate CPE...-PRSB
- [6] H-rail to EN 50002 for mounting
- [7] Clamping screw for H-rail
- [8] Location for inscription label  
type IBS 6 x 10
- [9] Connecting component

Size	B1	B2	B3	B4	B5	B6	B7	D1	D2 ∅	H1	H2	H3	H4
CPE14	114.6	105.6	50	93	89	80	3	G3/8	4.3	~84	~48	~40	46.4

Size	L1 <sup>1)</sup>			L2	L3	L4	L5	L6	L7	L8	L9
CPE14	32+(n×16)+12.4			32	32	48	12.4	10.1	-	4	32

1) n = number of valve positions

Technical data – Modular manifold

Combination options			
Number of valve positions	One pressure zone	Two pressure zones	
		Variant 1	Variant 2
2	1x CPE...-PRSG-2	–	–
3	1x CPE...-PRSG-3	–	–
4	1x CPE...-PRSGO-2 1x CPE...-PRSE-2	1x CPE...-PRSG-2 1x CPE...-PRSEO-2 1x CPE...-PRS-EP	–
5	1x CPE...-PRSGO-3 1x CPE...-PRSE-2	1x CPE...-PRSG-3 1x CPE...-PRSEO-2 1x CPE...-PRS-EP	–
6	1x CPE...-PRSGO-2 1x CPE...-PRSEO-2 1x CPE...-PRSE-2	1x CPE...-PRSG-2 2x CPE...-PRSEO-2 1x CPE...-PRS-EP	1x CPE...-PRSGO-2 1x CPE...-PRSE-2 1x CPE...-PRSEO-2 1x CPE...-PRS-EP
7	1x CPE...-PRSGO-3 2x CPE...-PRSEO-2 1x CPE...-PRS-EP	1x CPE...-PRSG-3 2x CPE...-PRSEO-2 1x CPE...-PRS-EP	1x CPE...-PRSGO-3 1x CPE...-PRSE-2 1x CPE...-PRSEO-2 1x CPE...-PRS-EP
8	1x CPE...-PRSGO-2 3x CPE...-PRSEO-2 1x CPE...-PRS-EP	1x CPE...-PRSG-2 3x CPE...-PRSEO-2 1x CPE...-PRS-EP	1x CPE...-PRSGO-2 1x CPE...-PRSE-2 2x CPE...-PRSEO-2 1x CPE...-PRS-EP
9	1x CPE...-PRSGO-3 3x CPE...-PRSEO-2 1x CPE...-PRS-EP	1x CPE...-PRSG-3 3x CPE...-PRSEO-2 1x CPE...-PRS-EP	1x CPE...-PRSGO-3 1x CPE...-PRSE-2 2x CPE...-PRSEO-2 1x CPE...-PRS-EP
10	1x CPE...-PRSGO-2 4x CPE...-PRSEO-2 1x CPE...-PRS-EP	1x CPE...-PRSG-2 4x CPE...-PRSEO-2 1x CPE...-PRS-EP	1x CPE...-PRSGO-2 1x CPE...-PRSE-2 3x CPE...-PRSEO-2 1x CPE...-PRS-EP
11	1x CPE...-PRSGO-3 4x CPE...-PRSEO-2 1x CPE...-PRS-EP	1x CPE...-PRSG-3 4x CPE...-PRSEO-2 1x CPE...-PRS-EP	1x CPE...-PRSGO-3 1x CPE...-PRSE-2 3x CPE...-PRSEO-2 1x CPE...-PRS-EP
12	1x CPE...-PRSGO-2 5x CPE...-PRSEO-2 1x CPE...-PRS-EP	1x CPE...-PRSG-2 5x CPE...-PRSEO-2 1x CPE...-PRS-EP	1x CPE...-PRSGO-2 1x CPE...-PRSE-2 4x CPE...-PRSEO-2 1x CPE...-PRS-EP

 - **Note**

Each air supply can support a maximum of 6 valve positions. Use valve manifold blocks only in combination with 5/2- and 5/3-way valves.

Ordering data – Modular manifold

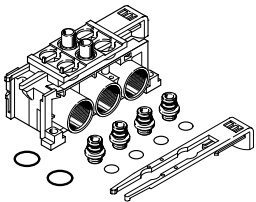
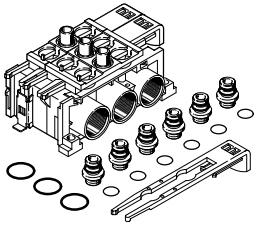
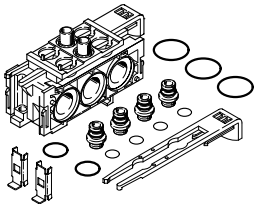
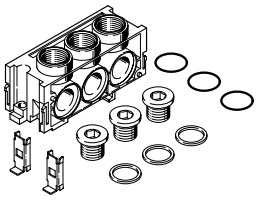
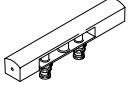
Ordering data	Port 1, 3, 5	PRS ducts	Weight [g]	Part no.	Type
<b>Manifold block PRSG for 2 valves</b>					
	G3/8	Closed	95	<b>164965</b>	<b>CPE14-PRSG-2</b>
	G3/8	Open	95	<b>187829</b>	<b>CPE14-PRSGO-2</b>
<b>Manifold block PRSG for 3 valves</b>					
	G3/8	Closed	130	<b>187824</b>	<b>CPE14-PRSG-3</b>
	G3/8	Open	130	<b>187820</b>	<b>CPE14-PRSGO-3</b>
<b>Manifold block PRSE for 2 valves</b>					
	–	Closed	85	<b>164967</b>	<b>CPE14-PRSE-2</b>
	–	Open	85	<b>187830</b>	<b>CPE14-PRSEO-2</b>
<b>End plate for manifold</b>					
	G3/8	–	80	<b>164969</b>	<b>CPE14-PRS-EP</b>
<b>Cover plate for vacant position</b>					
	–	–	15	<b>164968</b>	<b>CPE14-PRSB</b>

## Type codes

001	Series
CPE	Solenoid valve, Compact Performance
002	Width
18	18 mm
003	Nominal operating voltage
	None
M1	24 V DC
M2	110 V AC
M3	230 V AC
004	Electrical connection
H	Plug pattern ZC
P1	Interface for pilot valve size 15 mm to ISO 15218 (CNOMO)

005	Valve function
5L	5/2-way valve, monostable
5J	5/2-way valve, bistable
3GL	3/2-way valve, normally closed
3OL	3/2-way valve, normally open
5/3G	5/3-way valve, mid-position closed
5/3E	5/3-way valve, mid-position exhausted
5/3B	5/3-way valve, mid-position pressurised
006	Pilot air
	Internal
S	External
007	Pneumatic connection
1/4	G1/4
QS-8	Push-in connector 8 mm
QS-10	Push-in connector 10 mm



## Datasheet

### Functions:

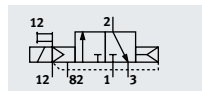
3/2G, 3/2O,  
5/2-way single solenoid  
5/2-way double pilot valve  
5/3G, 5/3B, 5/3E



3/2G with external pilot air supply,  
normally closed

-  - Width 18 mm
-  - Flow rate  
850 ... 1500 l/min
-  - Voltage for  
complete valves  
24 V DC, 110, 230 V AC  
Basic valves  
12, 24 V DC, 24, 110,  
230 V AC

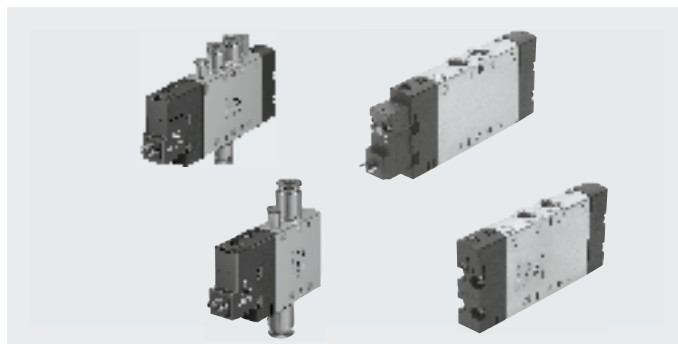

General technical data			3/2		5/2		5/3			
Valve function			3/2		5/2		5/3			
Normal position			G <sup>1)</sup>	O <sup>2)</sup>	-	-	G <sup>1)</sup>	B <sup>2)</sup>	E <sup>3)</sup>	
Stable position			Monostable			Bistable		Monostable		
Pneumatic spring reset			Yes			-		No		
Mechanical spring reset			No			-		Yes		
Design			Piston spool							
Sealing principle			Soft							
Overlap			Positive overlap							
Actuation type			Electrical							
Type of control			Piloted							
Pilot interface			To ISO 15218 or none for integrated pilot valve							
Pilot air supply			Internal or external							
Flow direction			-		Reversible with external pilot air supply					
Exhaust function			-		Can be throttled					
Manual override			Non-detenting, detenting via accessory							
Type of mounting			Via through-holes							
Mounting position			Any							
Pneumatic connection	1, 2, 4		Threaded connection: G1/4, QS connection: Ø 8 or Ø 10 mm							
	3, 5		Threaded connection: G1/4							
	12, 14		Threaded connection: M5, QS connection: Ø 4 mm							
	82, 84		Threaded connection: M5							
Nominal width	[mm]	8								
Standard nominal flow rate	G1/4	[l/min]	1300		1300		1450		1200 1300	
	QS8	[l/min]	850						780	
	QS10	[l/min]	1000				1050		1000	
Switching time	On/Off	[ms]	28/18, 36/30 <sup>5)</sup>		26/20, 32/30 <sup>5)</sup>		-		20/38, 20/34 <sup>5)</sup>	
	Reverse	[ms]	-				13, 15 <sup>5)</sup>		-	
Duty cycle	[%]	100								
Width	[mm]	18								
Conforms to standard			ISO 15218 in the case of interface with pilot valve							
Corrosion resistance class CRC <sup>4)</sup>			2							
CE marking (see declaration of conformity) <sup>6)</sup>			To EU Low Voltage Directive <sup>7)</sup>							
UKCA marking (see declaration of conformity) <sup>6)</sup>			To UK regulations for electrical equipment <sup>7)</sup>							

1) G = normally closed

2) O, B = normally open

3) E = normally exhausted

4) More information: [www.festo.com/x/topic/kbk](http://www.festo.com/x/topic/kbk)

5) Switching time for basic valve

6) For information about the area of use, see the EC declaration of conformity at: [www.festo.com/catalogue/...](http://www.festo.com/catalogue/...) → Support/Downloads.

If the devices are subject to usage restrictions in residential, commercial or light-industrial environments, further measures for the reduction of the emitted interference may be necessary.

7) Only for CPE18-M2H-... and CPE18-M3H-...

## Datasheet

Operating and environmental conditions			
Valve function		3/2	5/2-way, single solenoid   5/2-way, double solenoid   5/3
Operating medium	Compressed air to ISO 8573-1:2010 [7:4:4]		
Pilot medium	Compressed air to ISO 8573-1:2010 [7:4:4]		
Note on the operating/pilot medium	Lubricated operation possible (in which case lubricated operation will always be required)		
Operating pressure	Internal pilot air supply	[bar]	2.5 ... 10
	External pilot air supply	[MPa]	-0.09 ... 1
		[bar]	-0.9 ... 10
Pilot pressure		[MPa]	0.25 ... 1
		[bar]	2.5 ... 10
Ambient temperature		[°C]	-5 ... +50
Temperature of medium		[°C]	-5 ... +50
Certification for solenoid valves	c UL us - Recognized (OL)		
Maritime classification <sup>1)</sup>	See certificate		
Certificate-issuing authority	DNV-TAA000032X		
	UL MH19482		

1) Additional information: [www.festo.com/sp](http://www.festo.com/sp) → Certificates.

Electrical data			
Operating voltage	M1H	[V DC]	24 +10/-15%
	M2H	[V AC]	110 ±10% with 50 ... 60 Hz
	M3H	[V AC]	230 ±10% with 50 ... 60 Hz
Power consumption	M1H	[W]	1.5
	M2H, M3H	[VA]	Pull: 3, hold: 2.4
Degree of protection with plug socket	IP65 to IEC 60529		

### Materials

Sectional view

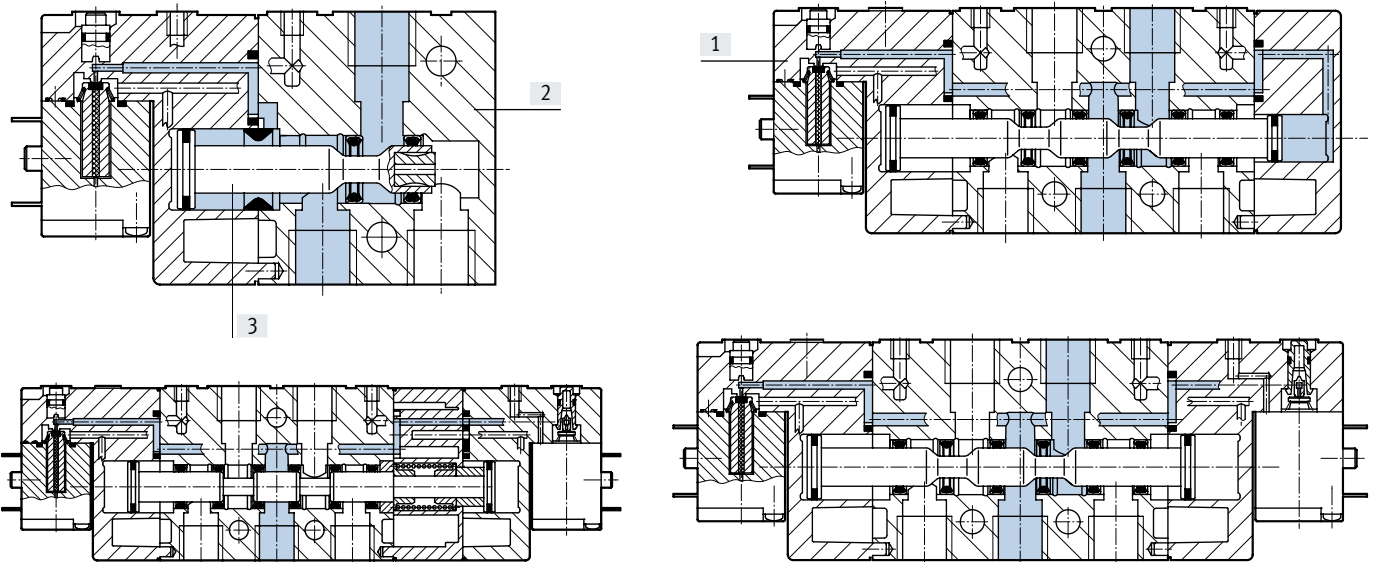

[1] Cover	PA
[2] Housing	Die-cast aluminium
[3] Piston spool	Steel
- Seals	NBR
Note on materials	RoHS-compliant

Datasheet

Dimensions – 3/2-way valve

Download CAD data → [www.festo.com](http://www.festo.com)

CPE18-...-1/4

CPE18-...-QS-8

CPE18-...-QS-10

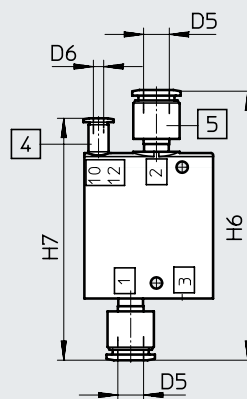
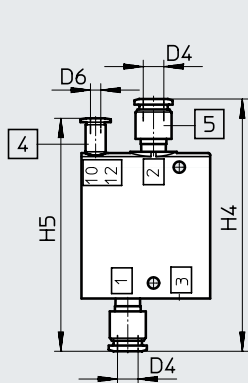
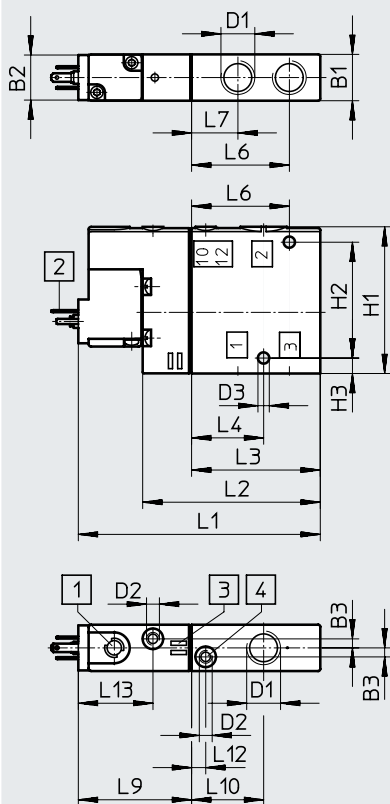

- [1] Manual override
- [2] Plug type C, to EN 175301-803
- [3] Space for inscription labels
- [4] Port 10/12 for external pilot air supply
- [5] QS push-in fitting

Type	B1	B2	B3	D1	D2	D3 ∅	D4 ∅	D5 ∅	D6 ∅	H1	H2	H3	H4	H5	H6	H7
CPE18-M1H-3...	18	17.5	3.5	G1/4	M5	4.4	8	10	4	57	45	6	98	90.5	105	94

Type	L1	L2	L3	L4	L6	L7	L9	L10	L12	L13
CPE18-M1H-3...	94	69	50	28	38	18	44	28	5.5	29

Datasheet

Dimensions – 5/2-way single solenoid valve Download CAD data → [www.festo.com](http://www.festo.com)

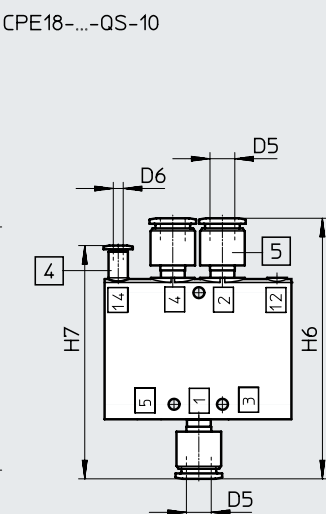
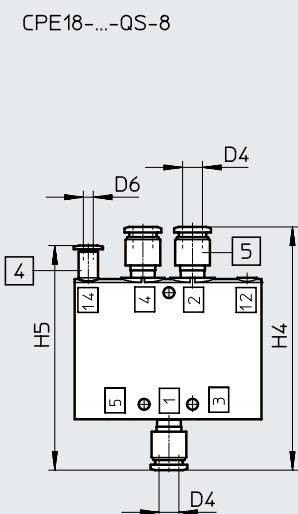
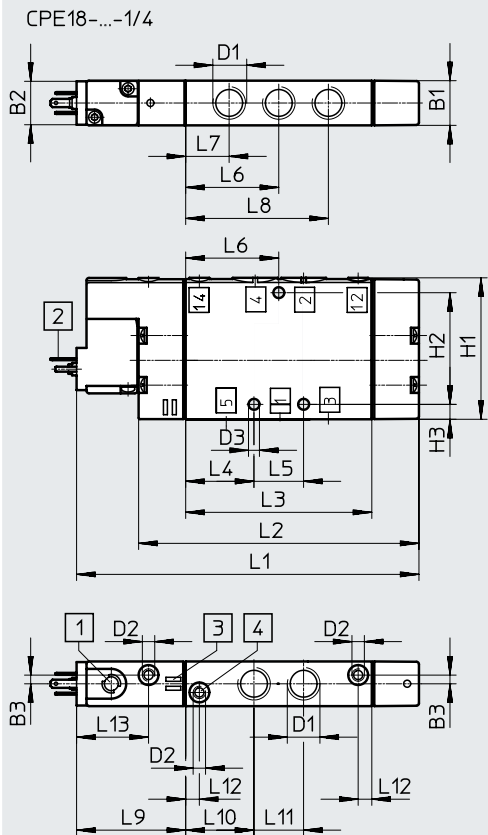

- [1] Manual override
- [2] Plug type C, to EN 175301-803
- [3] Space for inscription labels
- [4] Port 12/14 for external pilot air supply
- [5] QS push-in fitting

Type	B1	B2	B3	D1	D2	D3 ∅	D4 ∅	D5 ∅	D6 ∅	H1	H2	H3	H4	H5	H6	H7
CPE18-M1H-5...	18	17.5	3.5	G1/4	M5	4.4	8	10	4	57	45	6	98	90.5	105	94

Type	L1	L2	L3	L4	L5	L6	L7	L8	L9	L10	L11	L12	L13
CPE18-M1H-5...	138	113	75	27.5	20	37.5	17.5	57.5	44	27.5	20	5.5	29



Datasheet

Dimensions – 5/2-way double solenoid valve

Download CAD data → [www.festo.com](http://www.festo.com)

CPE18-...-1/4

CPE18-...-QS-8

CPE18-...-QS-10

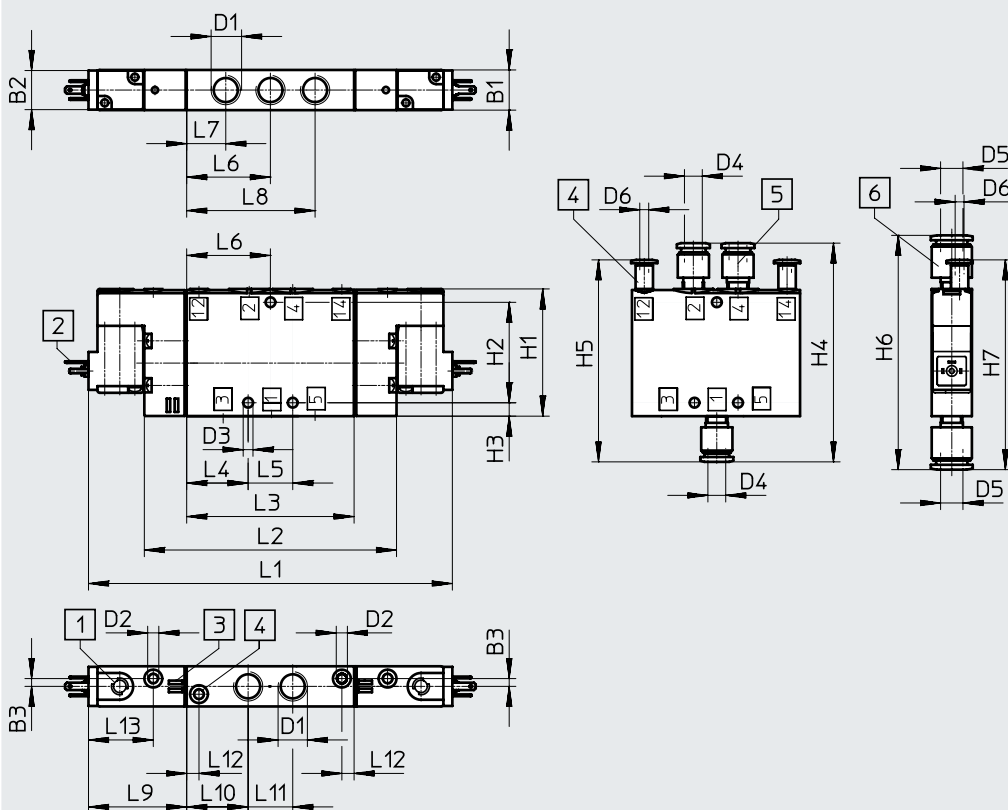

- [1] Manual override
- [2] Plug type C, to EN 175301-803
- [3] Space for inscription labels
- [4] Port 12/14 for external pilot air supply
- [5]/[6] QS push-in fitting

Type	B1	B2	B3	D1	D2	D3	D4	D5	D6	H1	H2	H3	H4	H5	H6	H7
CPE18-...-5J-1/4	18	17.5	3.5	G1/4	M5	4.4	8	10	4	57	45	6	98	90.5	105	94

Type	L1	L2	L3	L4	L5	L6	L7	L8	L9	L10	L11	L12	L13
CPE18-...-5J-1/4	163	113	75	27.5	20	37.5	17.5	57.5	44	27.5	20	5.5	29

Datasheet

Dimensions – 5/3-way valve

Download CAD data → [www.festo.com](http://www.festo.com)

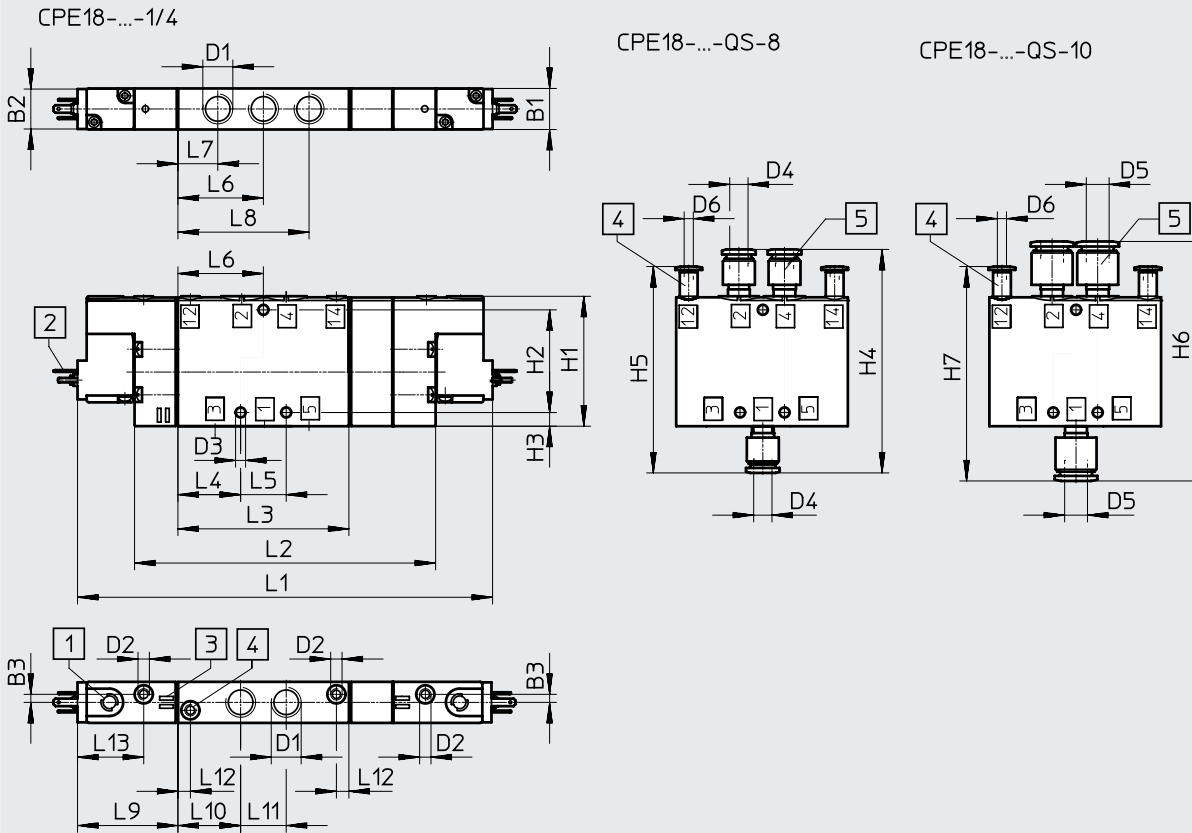

- [1] Manual override
- [2] Plug type C, to EN 175301-803
- [3] Space for inscription labels
- [4] Port 12/14 for external pilot air supply
- [5] QS push-in fitting

Type	B1	B2	B3	D1	D2	D3 ∅	D4 ∅	D5 ∅	D6 ∅	H1	H2	H3	H4	H5	H6	H7
CPE18-M1H...-5L	18	17.5	3.5	G1/4	M5	4.4	8	10	4	57	45	6	98	90.5	105	94
CPE18-M1H...-5/3																

Type	L1	L2	L3	L4	L5	L6	L7	L8	L9	L10	L11	L12	L13
CPE18-M1H...-5J	163	113	75	27.5	20	37.5	17.5	57.5	44	27.5	20	5.5	29
CPE18-M1H...-5/3	182	132											

## Ordering data

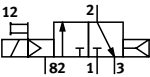
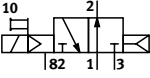
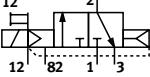
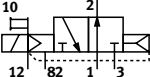
Ordering data – 3/2-way valve						
Circuit symbol	Pilot air supply	Voltage	Pneumatic connection	Weight [g]	Part no.	Type
<b>Normally closed</b>						
	Internal	24 V DC	G1/4	150	163141	CPE18-M1H-3GL-1/4
			QS-8	–	163149	CPE18-M1H-3GL-QS-8
			QS-10	–	163157	CPE18-M1H-3GL-QS-10
		110 V AC	G1/4	150	163761	CPE18-M2H-3GL-1/4
			QS-8	–	163769	CPE18-M2H-3GL-QS-8
			QS-10	–	163777	CPE18-M2H-3GL-QS-10
		230 V AC	G1/4	150	163785	CPE18-M3H-3GL-1/4
			QS-8	–	163793	CPE18-M3H-3GL-QS-8
			QS-10	–	163801	CPE18-M3H-3GL-QS-10
<b>Normally open</b>						
	Internal	24 V DC	G1/4	150	163140	CPE18-M1H-3OL-1/4
			QS-8	–	163148	CPE18-M1H-3OL-QS-8
			QS-10	–	163156	CPE18-M1H-3OL-QS-10
		110 V AC	G1/4	150	163760	CPE18-M2H-3OL-1/4
			QS-8	–	163768	CPE18-M2H-3OL-QS-8
			QS-10	–	163776	CPE18-M2H-3OL-QS-10
		230 V AC	G1/4	150	163784	CPE18-M3H-3OL-1/4
			QS-8	–	163792	CPE18-M3H-3OL-QS-8
			QS-10	–	163800	CPE18-M3H-3OL-QS-10
<b>Normally closed</b>						
	External	24 V DC	G1/4	150	163145	CPE18-M1H-3GLS-1/4
			QS-8	–	163153	CPE18-M1H-3GLS-QS-8
			QS-10	–	163161	CPE18-M1H-3GLS-QS-10
		110 V AC	G1/4	150	163765	CPE18-M2H-3GLS-1/4
			QS-8	–	163773	CPE18-M2H-3GLS-QS-8
			QS-10	–	163781	CPE18-M2H-3GLS-QS-10
		230 V AC	G1/4	150	163789	CPE18-M3H-3GLS-1/4
			QS-8	–	163797	CPE18-M3H-3GLS-QS-8
			QS-10	–	163805	CPE18-M3H-3GLS-QS-10
<b>Normally open</b>						
	External	24 V DC	G1/4	150	163144	CPE18-M1H-3OLS-1/4
			QS-8	–	163152	CPE18-M1H-3OLS-QS-8
			QS-10	–	163160	CPE18-M1H-3OLS-QS-10
		110 V AC	G1/4	150	163764	CPE18-M2H-3OLS-1/4
			QS-8	–	163772	CPE18-M2H-3OLS-QS-8
			QS-10	–	163780	CPE18-M2H-3OLS-QS-10
		230 V AC	G1/4	150	163788	CPE18-M3H-3OLS-1/4
			QS-8	–	163796	CPE18-M3H-3OLS-QS-8
			QS-10	–	163804	CPE18-M3H-3OLS-QS-10

## Ordering data

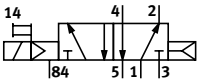
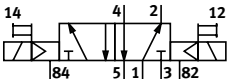
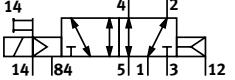
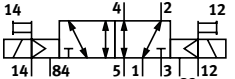
Ordering data – 5/2-way valve Circuit symbol	Pilot air supply	Voltage	Pneumatic connection	Weight [g]	Part no.	Type		
<b>5/2-way valve, single solenoid</b>								
	Internal	24 V DC	G1/4	220	163142	CPE18-M1H-5L-1/4		
			QS-8	–	163150	CPE18-M1H-5L-QS-8		
			QS-10	–	163158	CPE18-M1H-5L-QS-10		
		110 V AC	Internal	24 V DC	G1/4	220	163762	CPE18-M2H-5L-1/4
					QS-8	–	163770	CPE18-M2H-5L-QS-8
					QS-10	–	163778	CPE18-M2H-5L-QS-10
		230 V AC	Internal	24 V DC	G1/4	220	163786	CPE18-M3H-5L-1/4
					QS-8	–	163794	CPE18-M3H-5L-QS-8
					QS-10	–	163802	CPE18-M3H-5L-QS-10
<b>5/2-way double pilot valve</b>								
	Internal	24 V DC	G1/4	270	163143	CPE18-M1H-5J-1/4		
			QS-8	–	163151	CPE18-M1H-5J-QS-8		
			QS-10	–	163159	CPE18-M1H-5J-QS-10		
		110 V AC	Internal	24 V DC	G1/4	270	163763	CPE18-M2H-5J-1/4
					QS-8	–	163771	CPE18-M2H-5J-QS-8
					QS-10	–	163779	CPE18-M2H-5J-QS-10
		230 V AC	Internal	24 V DC	G1/4	270	163787	CPE18-M3H-5J-1/4
					QS-8	–	163795	CPE18-M3H-5J-QS-8
					QS-10	–	163803	CPE18-M3H-5J-QS-10
<b>5/2-way valve, single solenoid</b>								
	External	24 V DC	G1/4	220	163146	CPE18-M1H-5LS-1/4		
			QS-8	–	163154	CPE18-M1H-5LS-QS-8		
			QS-10	–	163162	CPE18-M1H-5LS-QS-10		
		110 V AC	External	24 V DC	G1/4	220	163766	CPE18-M2H-5LS-1/4
					QS-8	–	163774	CPE18-M2H-5LS-QS-8
					QS-10	–	163782	CPE18-M2H-5LS-QS-10
		230 V AC	External	24 V DC	G1/4	220	163790	CPE18-M3H-5LS-1/4
					QS-8	–	163798	CPE18-M3H-5LS-QS-8
					QS-10	–	163806	CPE18-M3H-5LS-QS-10
<b>5/2-way double pilot valve</b>								
	External	24 V DC	G1/4	270	163147	CPE18-M1H-5JS-1/4		
			QS-8	–	163155	CPE18-M1H-5JS-QS-8		
			QS-10	–	163163	CPE18-M1H-5JS-QS-10		
		110 V AC	External	24 V DC	G1/4	270	163767	CPE18-M2H-5JS-1/4
					QS-8	–	163775	CPE18-M2H-5JS-QS-8
					QS-10	–	163783	CPE18-M2H-5JS-QS-10
		230 V AC	External	24 V DC	G1/4	270	163791	CPE18-M3H-5JS-1/4
					QS-8	–	163799	CPE18-M3H-5JS-QS-8
					QS-10	–	163807	CPE18-M3H-5JS-QS-10

## Ordering data

Ordering data – 5/3-way valve Circuit symbol	Pilot air supply	Voltage	Pneumatic connection	Weight [g]	Part no.	Type		
<b>5/3-way mid-position valve, normally closed</b>								
	Internal	24 V DC	G1/4	280	170247	CPE18-M1H-5/3G-1/4		
			QS-8	–	170253	CPE18-M1H-5/3G-QS-8		
			QS-10	–	170259	CPE18-M1H-5/3G-QS-10		
		110 V AC	Internal	24 V DC	G1/4	280	170283	CPE18-M2H-5/3G-1/4
					QS-8	–	170289	CPE18-M2H-5/3G-QS-8
					QS-10	–	170295	CPE18-M2H-5/3G-QS-10
		230 V AC	Internal	24 V DC	G1/4	280	170319	CPE18-M3H-5/3G-1/4
					QS-8	–	170325	CPE18-M3H-5/3G-QS-8
					QS-10	–	170331	CPE18-M3H-5/3G-QS-10
<b>5/3-way mid-position valve, normally exhausted</b>								
	Internal	24 V DC	G1/4	280	170249	CPE18-M1H-5/3E-1/4		
			QS-8	–	170255	CPE18-M1H-5/3E-QS-8		
			QS-10	–	170261	CPE18-M1H-5/3E-QS-10		
		110 V AC	Internal	24 V DC	G1/4	280	170285	CPE18-M2H-5/3E-1/4
					QS-8	–	170291	CPE18-M2H-5/3E-QS-8
					QS-10	–	170297	CPE18-M2H-5/3E-QS-10
		230 V AC	Internal	24 V DC	G1/4	280	170321	CPE18-M3H-5/3E-1/4
					QS-8	–	170327	CPE18-M3H-5/3E-QS-8
					QS-10	–	170333	CPE18-M3H-5/3E-QS-10
<b>5/3-way mid-position valve, normally open</b>								
	Internal	24 V DC	G1/4	280	170251	CPE18-M1H-5/3B-1/4		
			QS-8	–	170257	CPE18-M1H-5/3B-QS8		
			QS-10	–	170263	CPE18-M1H-5/3B-QS10		
		110 V AC	Internal	24 V DC	G1/4	280	170287	CPE18-M2H-5/3B-1/4
					QS-8	–	170293	CPE18-M2H-5/3B-QS-8
					QS-10	–	170299	CPE18-M2H-5/3B-QS-10
		230 V AC	Internal	24 V DC	G1/4	280	170323	CPE18-M3H-5/3B-1/4
					QS-8	–	170329	CPE18-M3H-5/3B-QS-8
					QS-10	–	170335	CPE18-M3H-5/3B-QS-10

## Ordering data

Ordering data – 5/3-way valve Circuit symbol	Pilot air supply	Voltage	Pneumatic connection	Weight [g]	Part no.	Type		
<b>5/3-way mid-position valve, normally closed</b>								
	External	24 V DC	G1/4	280	<b>170248</b>	CPE18-M1H-5/3GS-1/4		
			QS-8	–	<b>170254</b>	CPE18-M1H-5/3GS-QS-8		
			QS-10	–	<b>170260</b>	CPE18-M1H-5/3GS-QS-10		
		110 V AC	External	24 V DC	G1/4	280	<b>170284</b>	CPE18-M2H-5/3GS-1/4
					QS-8	–	<b>170290</b>	CPE18-M2H-5/3GS-QS-8
					QS-10	–	<b>170296</b>	CPE18-M2H-5/3GS-QS-10
		230 V AC	External	24 V DC	G1/4	280	<b>170320</b>	CPE18-M3H-5/3GS-1/4
					QS-8	–	<b>170326</b>	CPE18-M3H-5/3GS-QS-8
					QS-10	–	<b>170332</b>	CPE18-M3H-5/3GS-QS-10
<b>5/3-way mid-position valve, normally exhausted</b>								
	External	24 V DC	G1/4	280	<b>170250</b>	CPE18-M1H-5/3ES-1/4		
			QS-8	–	<b>170256</b>	CPE18-M1H-5/3ES-QS-8		
			QS-10	–	<b>170262</b>	CPE18-M1H-5/3ES-QS-10		
		110 V AC	External	24 V DC	G1/4	280	<b>170286</b>	CPE18-M2H-5/3ES-1/4
					QS-8	–	<b>170292</b>	CPE18-M2H-5/3ES-QS-8
					QS-10	–	<b>170298</b>	CPE18-M2H-5/3ES-QS-10
		230 V AC	External	24 V DC	G1/4	280	<b>170322</b>	CPE18-M3H-5/3ES-1/4
					QS-8	–	<b>170328</b>	CPE18-M3H-5/3ES-QS-8
					QS-10	–	<b>170334</b>	CPE18-M3H-5/3ES-QS-10
<b>5/3-way mid-position valve, normally open</b>								
	External	24 V DC	G1/4	280	<b>170252</b>	CPE18-M1H-5/3BS-1/4		
			QS-8	–	<b>170258</b>	CPE18-M1H-5/3BS-QS-8		
			QS-10	–	<b>170264</b>	CPE18-M1H-5/3BS-QS-10		
		110 V AC	External	24 V DC	G1/4	280	<b>170288</b>	CPE18-M2H-5/3BS-1/4
					QS-8	–	<b>170294</b>	CPE18-M2H-5/3BS-QS-8
					QS-10	–	<b>170300</b>	CPE18-M2H-5/3BS-QS-10
		230 V AC	External	24 V DC	G1/4	280	<b>170324</b>	CPE18-M3H-5/3BS-1/4
					QS-8	–	<b>170330</b>	CPE18-M3H-5/3BS-QS-8
					QS-10	–	<b>170336</b>	CPE18-M3H-5/3BS-QS-10

Technical data – Directional control valves without pilot valve

Materials

Sectional view

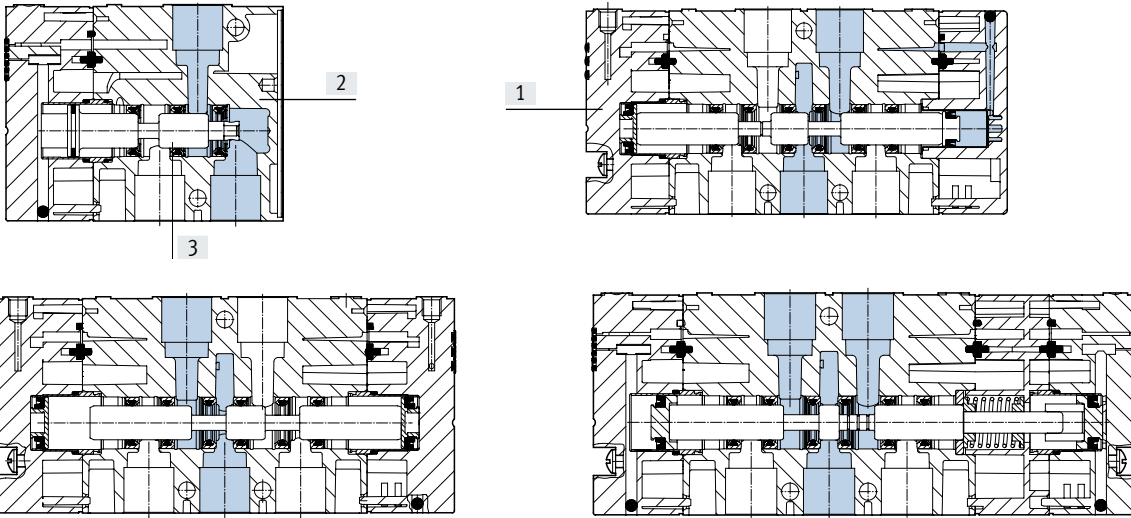

[1] Cover	PA
[2] Housing	Die-cast aluminium
[3] Piston spool	Steel
- Seals	NBR
Note on materials	RoHS-compliant

Dimensions – 3/2-way valve

Download CAD data → [www.festo.com](http://www.festo.com)

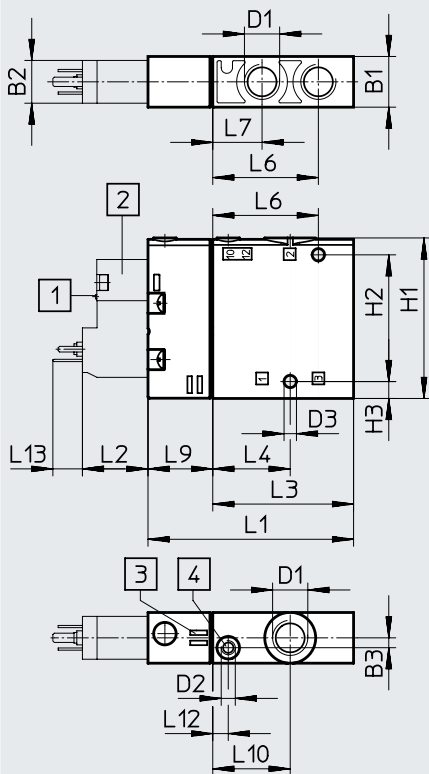

- [1] Manual override
- [2] Pilot valve, plug type C to EN 175301-803
- [3] Space for inscription label
- [4] Port 10/12 for external pilot air supply

Type	B1	B2	B3	D1	D2	D3 ∅	H1	H2	H3	L1	L2	L3	L4	L6	L7	L9	L10	L12	L13
CPE18-P1-3	18	15.2	3.5	G1/4	M5	4.4	57	45	6	73	23.3	50	27.5	37.5	17.5	23	27.5	5.5	10.5

Technical data – Directional control valves without pilot valve

Dimensions – 5/2-way valve

Download CAD data → [www.festo.com](http://www.festo.com)

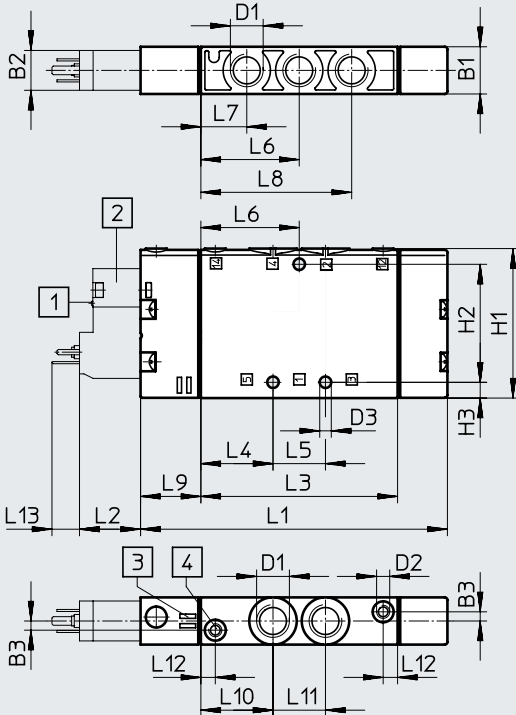

- [1] Manual override
- [2] Pilot valve, plug type C to EN 175301-803
- [3] Space for inscription label
- [4] Port 12/14 for external pilot air supply

Type	B1	B2	B3	D1	D2	D3	H1	H2	H3	L1	L2	L3	L4	L5	L6	L7	L8	L9	L10	L11	L12	L13
CPE18-P1-5L	18	15.2	3.5	G1/4	M5	4.4	57	45	6	117	23.3	75	27.5	20	37.5	17.5	57.5	23	27.5	20	5.5	10.5

Dimensions – 5/2-way double pilot valve

Download CAD data → [www.festo.com](http://www.festo.com)

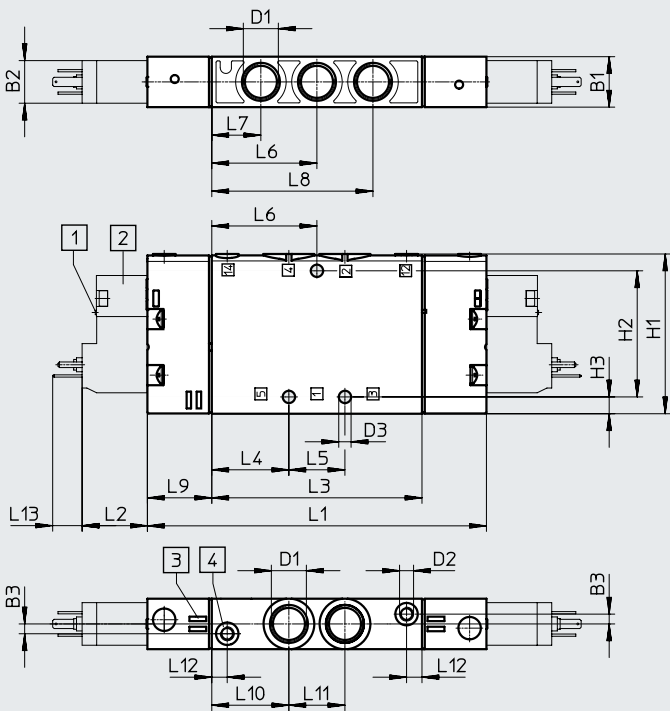

- [1] Manual override
- [2] Pilot valve, plug type C to EN 175301-803
- [3] Space for inscription label
- [4] Port 12/14 for external pilot air supply

Type	B1	B2	B3	D1	D2	D3	H1	H2	H3	L1	L2	L3	L4	L5	L6	L7	L8	L9	L10	L11	L12	L13
CPE18-P1-5J	18	15.2	3.5	G1/4	M5	4.4	57	45	6	121	23.3	75	27.5	20	37.5	17.5	57.5	23	27.5	20	5.5	10.5



Technical data – Directional control valves without pilot valve

Dimensions – 5/3-way valve

Download CAD data → [www.festo.com](http://www.festo.com)

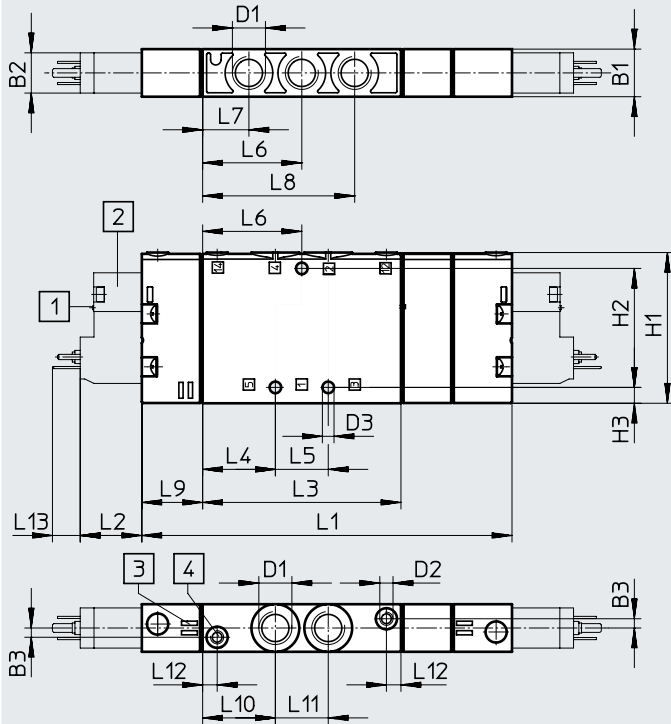

- [1] Manual override
- [2] Pilot valve, plug type C to EN 175301-803
- [3] Space for inscription label
- [4] Port 12/14 for external pilot air supply

Type	B1	B2	B3	D1	D2	D3 ∅	H1	H2	H3	L1	L2	L3	L4	L5	L6	L7	L8	L9	L10	L11	L12	L13
CPE18-P1-5J	18	15.2	3.5	G1/4	M5	4.4	57	45	6	121	23.3	75	27.5	20	37.5	17.5	57.5	23	27.5	20	5.5	10.5
CPE18-P1-5/3										140												

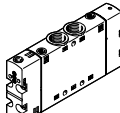

### Ordering data

Ordering data – 3/2-way valve without pilot valve					
Design type	Normal position	Pilot air supply	Weight [g]	Part no.	Type
	Closed	Internal	110	550163	CPE18-P1-3GL-1/4
	Open			550165	CPE18-P1-3OL-1/4
	Closed	External		550164	CPE18-P1-3GLS-1/4
	Open			550166	CPE18-P1-3OLS-1/4

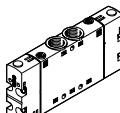
Ordering data – 5/2-way single solenoid valve without pilot valve					
Design type		Pilot air supply	Weight [g]	Part no.	Type
	–	Internal	180	550153	CPE18-P1-5L-1/4
		External		550154	CPE18-P1-5LS-1/4

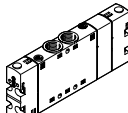
Ordering data – 5/2-way double pilot valve without pilot valve					
Design type		Pilot air supply	Weight [g]	Part no.	Type
	–	Internal	190	550155	CPE18-P1-5J-1/4
		External		550156	CPE18-P1-5JS-1/4

Ordering data – 5/3-way monostable mid-position valve without pilot valve					
Design type	Normal position	Pilot air supply	Weight [g]	Part no.	Type
	Closed	Internal	200	550157	CPE18-P1-5/3G-1/4
	Open			550159	CPE18-P1-5/3E-1/4
	Exhausted			550161	CPE18-P1-5/3B-1/4
	Closed	External		550158	CPE18-P1-5/3GS-1/4
	Open			550160	CPE18-P1-5/3ES-1/4
	Exhausted			550162	CPE18-P1-5/3BS-1/4

Ordering data – Pilot valve to ISO 15218								
Design type	Plug, square design	PE conductor	Power		Voltage		Part no.	Type
			[W]	[VA]	[V DC]	[V AC]		
	Type C to EN 175301-803	No	1.8	–	24	–	546256	VSCS-B-M32-MH-WA-1C1
					12	–	546257	VSCS-B-M32-MH-WA-5C1
	Type C to EN 175301-803	Yes	–	2.1	–	230	546260	VSCS-B-M32-MH-WA-3AC1
		Yes	–	2.1	–	110	546259	VSCS-B-M32-MH-WA-2AC1
	Type C to EN 175301-803	No	–	2.3	–	24	546258	VSCS-B-M32-MH-WA-1AC1

## Technical data – Fixed-grid manifold block

### Manifold block

For CPE18 5/2 and 5/3

Material:

Wrought aluminium alloy

RoHS-compliant

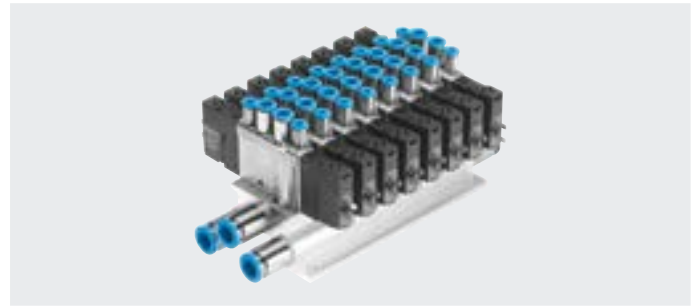

### Dimensions – Fixed-grid manifold 5/2 and 5/3

Download CAD data → [www.festo.com](http://www.festo.com)

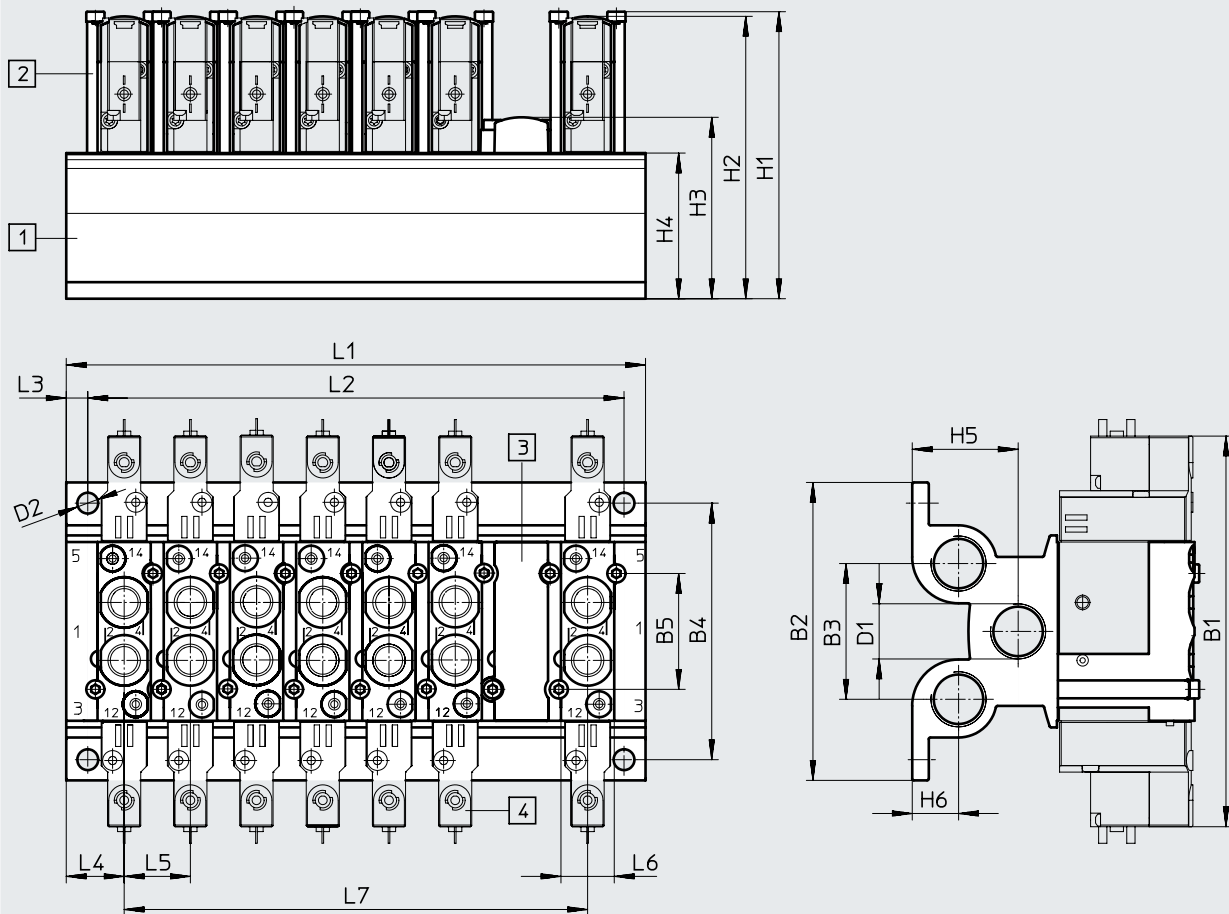

[1] Manifold block  
Grid dimension 26 mm

[2] Retaining bracket

[3] Cover plate

[4] Valves

Type	B1	B2	B3	B4	B5	D1	D2	H1	H2	H3	H4	H5	H6
CPE18-PRS...	155	102	46	86.5	40	G3/8	8.3	105	101.45	59.8	44	30.5	14





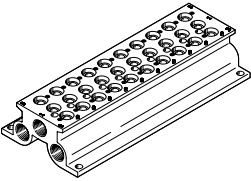

Type	L1	L2	L3	L4	L5	L6	L7
CPE18-PRS...	45 + (n-1) x 26	L1 - 17 ± 0.1	8.5	22.5	26	22.4	(n-1) x 26

Ordering data – Fixed-grid manifold block

Ordering data		Valve positions	CRC <sup>1)</sup>	Max. tightening torque for valve mounting [Nm]	Weight [g]	Part no.	Type
<b>Manifold block for 5/2- and 5/3-way valves</b>							
	2	2	2		353	543839	CPE18-PRS-3/8-2
	3				482	543840	CPE18-PRS-3/8-3
	4				611	543841	CPE18-PRS-3/8-4
	5				740	543842	CPE18-PRS-3/8-5
	6				870	543843	CPE18-PRS-3/8-6
	7				999	543844	CPE18-PRS-3/8-7
	8				1128	543845	CPE18-PRS-3/8-8
	9				1257	543846	CPE18-PRS-3/8-9
	10				1386	543847	CPE18-PRS-3/8-10

1) More information: [www.festo.com/x/topic/kbk](http://www.festo.com/x/topic/kbk)

Ordering data		Material	Part no.	Type
<b>Cover plate for vacant position</b>				
		PA	544481	CPE18-RP
<b>Retaining bracket set</b>				
		Retaining bracket: high-alloy stainless steel Screws: galvanised steel Seals: NBR	544396	CPE18-H5-SET
<b>Ordering data</b>				
		Material	Part no.	Type
<b>Retaining bracket</b>				
		Retaining bracket: high-alloy stainless steel (packaging unit 50 pieces)	547047	CPE18-H5-50
<b>Screws</b>				
		Galvanised steel (packaging unit 100 pieces)	547050	M4X65-8.8-VS-100
<b>Seals</b>				
		NBR (packaging unit 150 pieces)	547053	CPV18-VI-P.1/4-150

## Technical data – Fixed-grid manifold block

### Manifold block

For CPE18 3/2

Material:

Wrought aluminium alloy

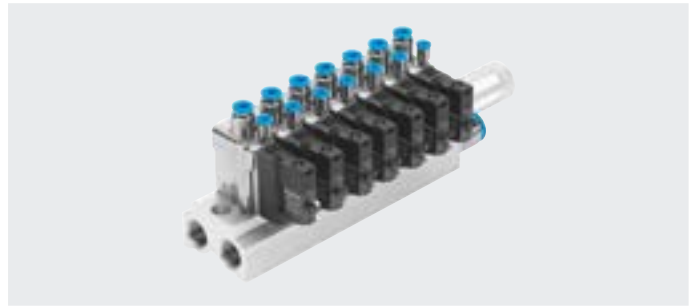

### Dimensions – Fixed-grid manifold block 3/2

Download CAD data → [www.festo.com](http://www.festo.com)

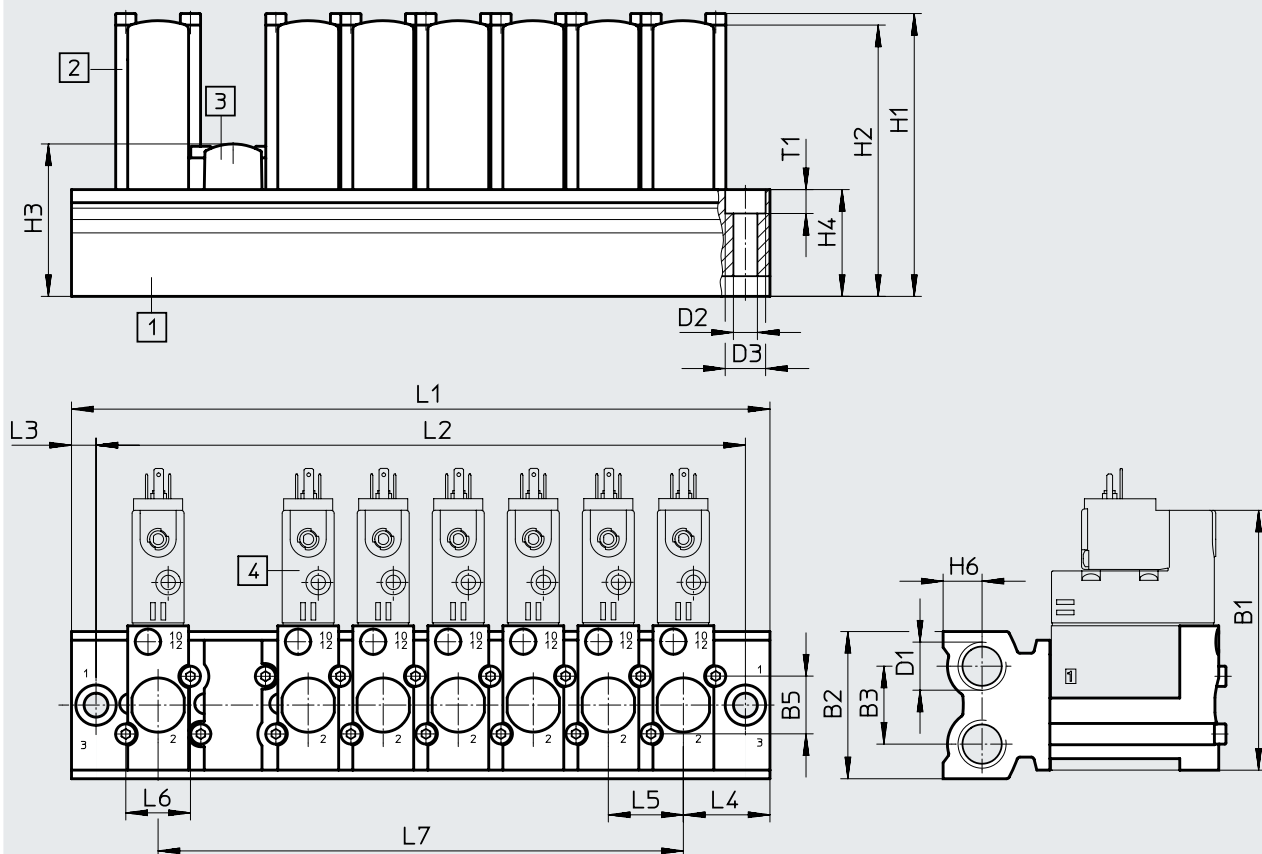

[1] Manifold block  
Grid dimension 26 mm

[2] Retaining bracket

[3] Cover plate

[4] Valves

Type	B1	B2	B3	B5	D1	D2	H1	H2	H3	H4	H6
CPE18-3/2-PRS...	90	51	27	200	G3/8	8.3	98	94	52.8	37	13.5

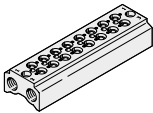

Type	L1	L2	L3	L4	L5	L6	L7	T1
CPE18-3/2-PRS...	$60 + (n-1) \times 26$	$43 + (n-1) \times 26$	8.5	24	26	22.4	$(n-1) \times 26$	8.3

Ordering data – Fixed-grid manifold block

Ordering data		Valve positions	CRC <sup>1)</sup>	Max. tightening torque for valve mounting [Nm]	Weight [g]	Part no.	Type
<b>Manifold block for 3/2-way valves</b>							
	2	2	2	2	266	550568	CPE18-3/2-PRS-3/8-2
	3				346	550569	CPE18-3/2-PRS-3/8-3
	4				426	550570	CPE18-3/2-PRS-3/8-4
	5				507	550571	CPE18-3/2-PRS-3/8-5
	6				587	550572	CPE18-3/2-PRS-3/8-6
	7				667	550573	CPE18-3/2-PRS-3/8-7
	8				748	550574	CPE18-3/2-PRS-3/8-8
	9				828	550575	CPE18-3/2-PRS-3/8-9
	10				908	550576	CPE18-3/2-PRS-3/8-10

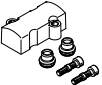
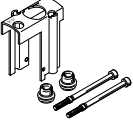
1) Más información en [www.festo.com/x/topic/kbk](http://www.festo.com/x/topic/kbk)

Ordering data		Material	Part no.	Type
<b>Cover plate</b>				
	PA		550582	CPE18-RP3
<b>Retaining bracket set</b>				
	Retaining bracket: high-alloy stainless steel Screws: galvanised steel Seals: NBR		550579	CPE18-H3-SET

Ordering data		Material	Part no.	Type
<b>Retaining bracket</b>				
	Retaining bracket: high-alloy stainless steel (packaging unit 50 pieces)		551492	CPE18-H3-50
<b>Screws</b>				
	Galvanised steel (packaging unit 100 pieces)		547050	M4X65-8.8-VS-100
<b>Seals</b>				
	NBR (packaging unit 150 pieces)		547053	CPV18-VI-P.1/4-150

## Technical data – Modular manifold

### Modular manifold block

For CPE18 5/2 and 5/3

Material:  
Reinforced PA

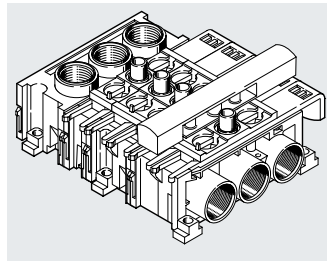

### Dimensions – Modular manifold block

Download CAD data → [www.festo.com](http://www.festo.com)

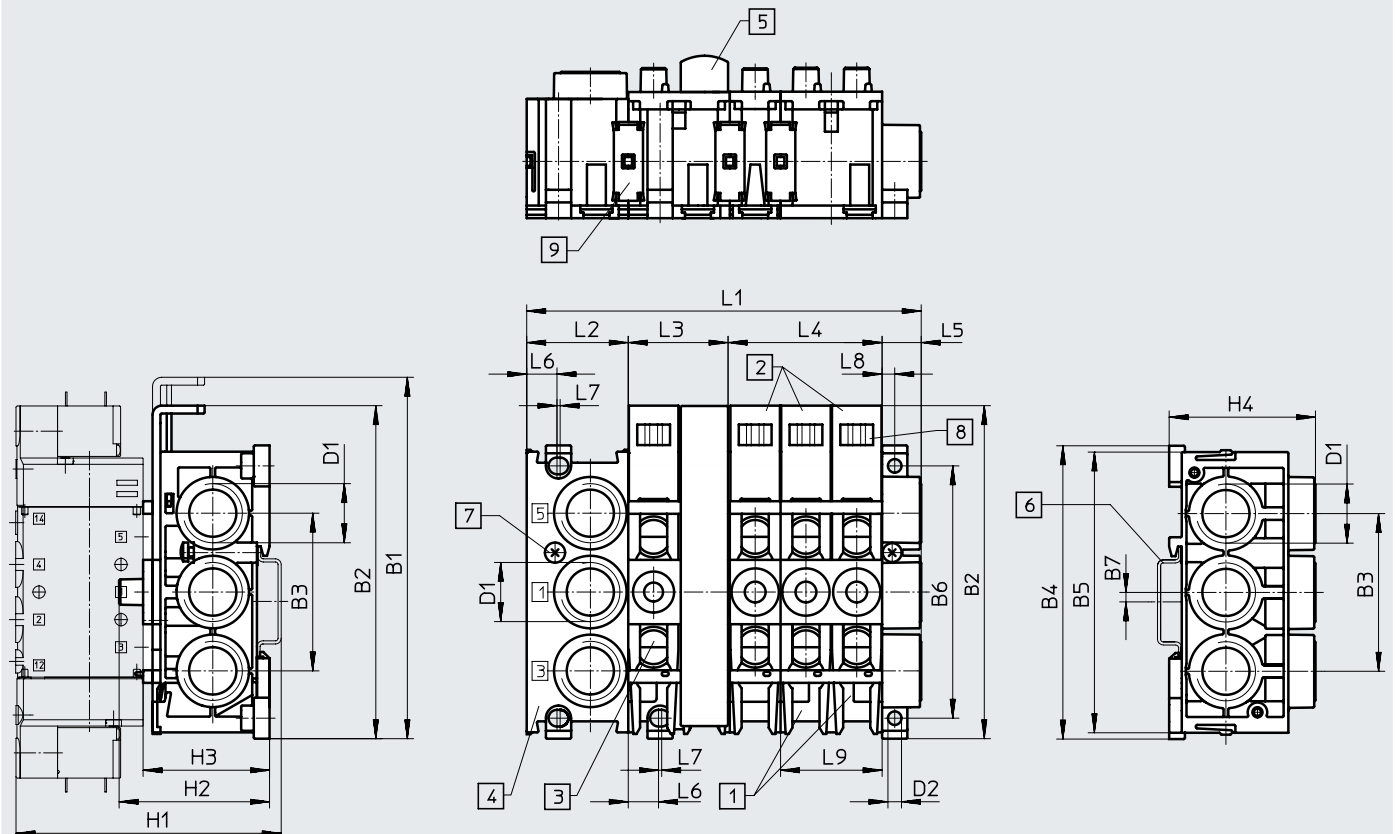

- |  |  |                                     |   |
|--|--|-------------------------------------|---|
| [1] Manifold block<br>CPE...-PRSG...-2 for<br>2 valves | [3] Expansion block<br>CPE...-PRSE...-2 for 2 valves | [6] H-rail to EN 50002 for mounting | [8] Location for inscription label<br>type IBS 6 x 10 |
| [2] Manifold block<br>CPE...-PRSG...-3 for<br>3 valves | [4] End block CPE...-PRS-EP                          | [7] Clamping screw for H-rail       | [9] Connecting component                              |
|  | [5] Cover plate CPE...-PRSB                          |                                     |   |

Size	B1	B2	B3	B4	B5	B6	B7	D1	D2 ∅	H1	H2	H3	H4
CPE18	151.6	136.5	59	113	-	100	2.75	G1/2	5.3	~106	~58	~46	51.4
Size	L1 <sup>1)</sup>			L2	L3	L4	L5	L6	L7	L8	L9		
CPE18	40+(n×20)+16.4			40	40	60	16.4	12.6	1	5.2	40		

1) n = number of valve positions

### Technical data – Modular manifold

Combination options			
Number of valve positions	One pressure zone	Two pressure zones	
		Variant 1	Variant 2
2	1x CPE...-PRSG-2	–	–
3	1x CPE...-PRSG-3	–	–
4	1x CPE...-PRSGO-2 1x CPE...-PRSE-2	1x CPE...-PRSG-2 1x CPE...-PRSEO-2 1x CPE...-PRS-EP	–
5	1x CPE...-PRSGO-3 1x CPE...-PRSE-2	1x CPE...-PRSG-3 1x CPE...-PRSEO-2 1x CPE...-PRS-EP	–
6	1x CPE...-PRSGO-2 1x CPE...-PRSEO-2 1x CPE...-PRSE-2	1x CPE...-PRSG-2 2x CPE...-PRSEO-2 1x CPE...-PRS-EP	1x CPE...-PRSGO-2 1x CPE...-PRSE-2 1x CPE...-PRSEO-2 1x CPE...-PRS-EP
7	1x CPE...-PRSGO-3 2x CPE...-PRSEO-2 1x CPE...-PRS-EP	1x CPE...-PRSG-3 2x CPE...-PRSEO-2 1x CPE...-PRS-EP	1x CPE...-PRSGO-3 1x CPE...-PRSE-2 1x CPE...-PRSEO-2 1x CPE...-PRS-EP
8	1x CPE...-PRSGO-2 3x CPE...-PRSEO-2 1x CPE...-PRS-EP	1x CPE...-PRSG-2 3x CPE...-PRSEO-2 1x CPE...-PRS-EP	1x CPE...-PRSGO-2 1x CPE...-PRSE-2 2x CPE...-PRSEO-2 1x CPE...-PRS-EP
9	1x CPE...-PRSGO-3 3x CPE...-PRSEO-2 1x CPE...-PRS-EP	1x CPE...-PRSG-3 3x CPE...-PRSEO-2 1x CPE...-PRS-EP	1x CPE...-PRSGO-3 1x CPE...-PRSE-2 2x CPE...-PRSEO-2 1x CPE...-PRS-EP
10	1x CPE...-PRSGO-2 4x CPE...-PRSEO-2 1x CPE...-PRS-EP	1x CPE...-PRSG-2 4x CPE...-PRSEO-2 1x CPE...-PRS-EP	1x CPE...-PRSGO-2 1x CPE...-PRSE-2 3x CPE...-PRSEO-2 1x CPE...-PRS-EP
11	1x CPE...-PRSGO-3 4x CPE...-PRSEO-2 1x CPE...-PRS-EP	1x CPE...-PRSG-3 4x CPE...-PRSEO-2 1x CPE...-PRS-EP	1x CPE...-PRSGO-3 1x CPE...-PRSE-2 3x CPE...-PRSEO-2 1x CPE...-PRS-EP
12	1x CPE...-PRSGO-2 5x CPE...-PRSEO-2 1x CPE...-PRS-EP	1x CPE...-PRSG-2 5x CPE...-PRSEO-2 1x CPE...-PRS-EP	1x CPE...-PRSGO-2 1x CPE...-PRSE-2 4x CPE...-PRSEO-2 1x CPE...-PRS-EP

 - **Note**

Each air supply can support a maximum of 6 valve positions. Use valve manifold blocks only in combination with 5/2- and 5/3-way valves.

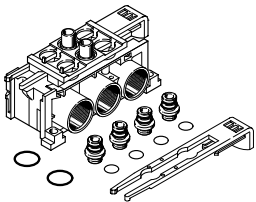
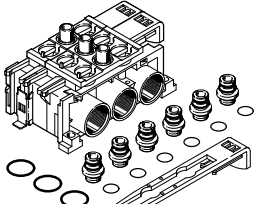
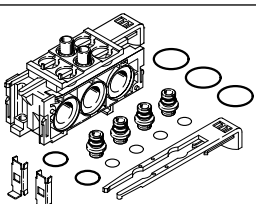
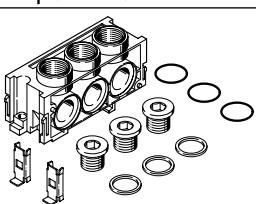
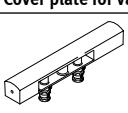

### Ordering data – Modular manifold

Ordering data	Port 1, 3, 5	PRS ducts	Weight [g]	Part no.	Type
<b>Manifold block PRSG for 2 valves</b>					
	G1/2	Closed	170	<b>164970</b>	<b>CPE18-PRSG-2</b>
	G1/2	Open	170	<b>187831</b>	<b>CPE18-PRSGO-2</b>
<b>Manifold block PRSG for 3 valves</b>					
	G1/2	Closed	225	<b>187825</b>	<b>CPE18-PRSG-3</b>
	G1/2	Open	225	<b>187821</b>	<b>CPE18-PRSGO-3</b>
<b>Manifold block PRSE for 2 valves</b>					
	–	Closed	145	<b>164972</b>	<b>CPE18-PRSE-2</b>
	–	Open	145	<b>187832</b>	<b>CPE18-PRSEO-2</b>
<b>End plate for manifold</b>					
	G1/2	–	125	<b>164973</b>	<b>CPE18-PRS-EP</b>
<b>Cover plate for vacant position</b>					
	–	–	28	<b>164974</b>	<b>CPE18-PRSB</b>

## Type codes

001	Series
CPE	Solenoid valve, Compact Performance

002	Width
24	24 mm

003	Nominal operating voltage
M1	24 V DC
M2	110 V AC
M3	230 V AC

004	Electrical connection
H	Plug pattern ZC

005	Valve function
5L	5/2-way valve, monostable
5J	5/2-way valve, bistable
3GL	3/2-way valve, normally closed
3OL	3/2-way valve, normally open
5/3G	5/3-way valve, mid-position closed
5/3E	5/3-way valve, mid-position exhausted
5/3B	5/3-way valve, mid-position pressurised

006	Pilot air
	Internal
S	External

007	Pneumatic connection
3/8	G3/8
QS-10	Push-in connector 10 mm
QS-12	Push-in connector 12 mm



## Datasheet

### Functions:

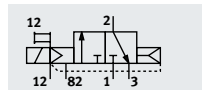
3/2G, 3/2O,  
5/2-way single solenoid  
5/2-way double pilot valve  
5/3G, 5/3B, 5/3E



3/2G with external pilot air supply, normally closed

-  - Width 24 mm
-  - Flow rate  
1250 ... 3200 l/min
-  - Voltage  
24 V DC, 110, 230 V AC  
basic valve  
12, 24 V DC,  
24, 110, 230 V AC

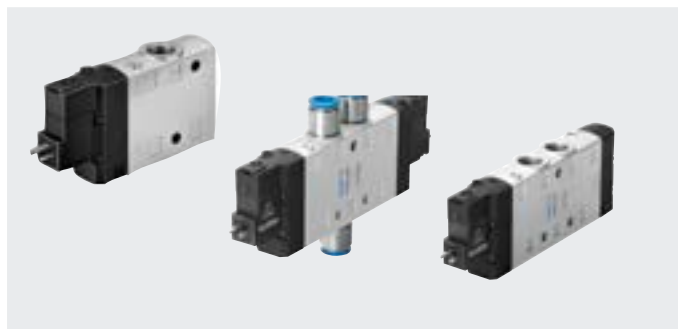

General technical data		3/2		5/2		5/3		
Valve function		G <sup>1)</sup>	O <sup>2)</sup>	-	-	G <sup>1)</sup>	B <sup>2)</sup>	E <sup>3)</sup>
Normal position		Monostable		Bistable		Monostable		
Stable position		Yes		-		No		
Pneumatic spring reset		No		-		Yes		
Mechanical spring reset		Piston spool						
Design		Soft						
Sealing principle		Positive overlap						
Overlap		Electrical						
Actuation type		Pilot						
Type of control		Internal or external						
Pilot air supply		-		Reversible with external pilot air supply				
Flow direction				Can be throttled				
Exhaust function		Non-detenting, detenting via accessory						
Manual override		Via through-holes						
Type of mounting		Any						
Mounting position		Threaded connection: G3/8, QS connection: $\varnothing$ 10 or $\varnothing$ 12 mm						
Pneumatic connection	1, 2, 4	Threaded connection: G3/8						
	3, 5	Threaded connection: G3/8						
	12, 14	Threaded connection: M5, QS connection: $\varnothing$ 6 mm						
	82, 84	Threaded connection: M5						
Nominal width	[mm]	11						
Standard nominal flow rate	G3/8 [l/min]	2500	2900	3200	3000	2600	2650	
	QS10 [l/min]	1250						
	QS12 [l/min]	1650						
Switching time	On/Off [ms]	50/33	40/50	-	25/55			
	Reverse [ms]	-		25	-			
Duty cycle	[%]	100						
Width	[mm]	24						
Corrosion resistance class CRC <sup>4)</sup>		2						
CE marking (see declaration of conformity) <sup>5)</sup>		To EU Low Voltage Directive <sup>6)</sup>						
UKCA marking (see declaration of conformity) <sup>5)</sup>		To UK regulations for electrical equipment <sup>6)</sup>						

1) G = normally closed

2) O, B = normally open

3) E = normally exhausted

4) More information: [www.festo.com/x/topic/kbk](http://www.festo.com/x/topic/kbk)

5) For information about the area of use, see the EC declaration of conformity at: [www.festo.com/catalogue/...](http://www.festo.com/catalogue/...) → Support/Downloads.

If the devices are subject to usage restrictions in residential, commercial or light-industrial environments, further measures for the reduction of the emitted interference may be necessary.

6) Only for CPE24-M2H-... and CPE24-M3H-...

## Datasheet

Operating and environmental conditions			
Valve function		3/2	5/2-way, single solenoid   5/2-way, double solenoid   5/3
Operating medium		Compressed air to ISO 8573-1:2010 [7:4:4]	
Pilot medium		Compressed air to ISO 8573-1:2010 [7:4:4]	
Note on the operating/pilot medium		Lubricated operation possible (in which case lubricated operation will always be required)	
Operating pressure	Internal pilot air supply	[MPa]	0.25 ... 1   0.2 ... 1   0.25 ... 1
		[bar]	2.5 ... 10   2 ... 10   2.5 ... 10
	External pilot air supply	[MPa]	-0.09 ... 1
		[bar]	-0.9 ... 10
Pilot pressure		[MPa]	0.25 ... 1   0.2 ... 1   0.25 ... 1
		[bar]	2.5 ... 10   2 ... 10   2.5 ... 10
Ambient temperature		[°C]	-5 ... +50
Temperature of medium		[°C]	-5 ... +50
Certification		c UL us - Recognized (OL)	
Maritime classification <sup>1)</sup>		See certificate	
Certificate-issuing authority		DNV-TAA000032X	
		UL MH19482	

1) Additional information: [www.festo.com/sp](http://www.festo.com/sp) → Certificates.

Electrical data			
Operating voltage	M1H	[V DC]	24 +10/-15%
	M2H	[V AC]	110 ±10% with 50 ... 60 Hz
	M3H	[V AC]	230 ±10% with 50 ... 60 Hz
Power consumption	M1H	[W]	1.5
	M2H, M3H	[VA]	Pull: 3, hold: 2.4
Degree of protection with plug socket			IP65 to IEC 60529

## Materials

Sectional view

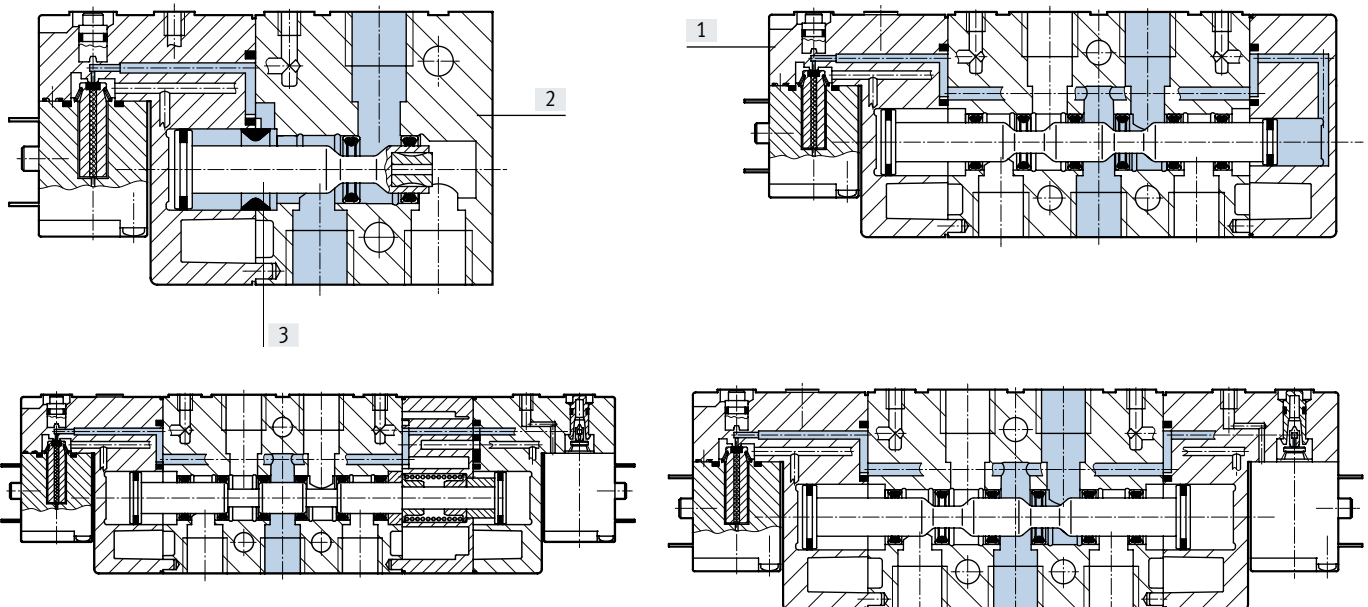

[1] Cover	PA
[2] Housing	Die-cast aluminium
[3] Piston spool	Steel
- Seals	NBR
Note on materials	RoHS-compliant

Datasheet

Dimensions – 3/2-way valve

Download CAD data → [www.festo.com](http://www.festo.com)

CPE24-...-3/8

CPE24-...-QS-10

CPE24-...-QS-12

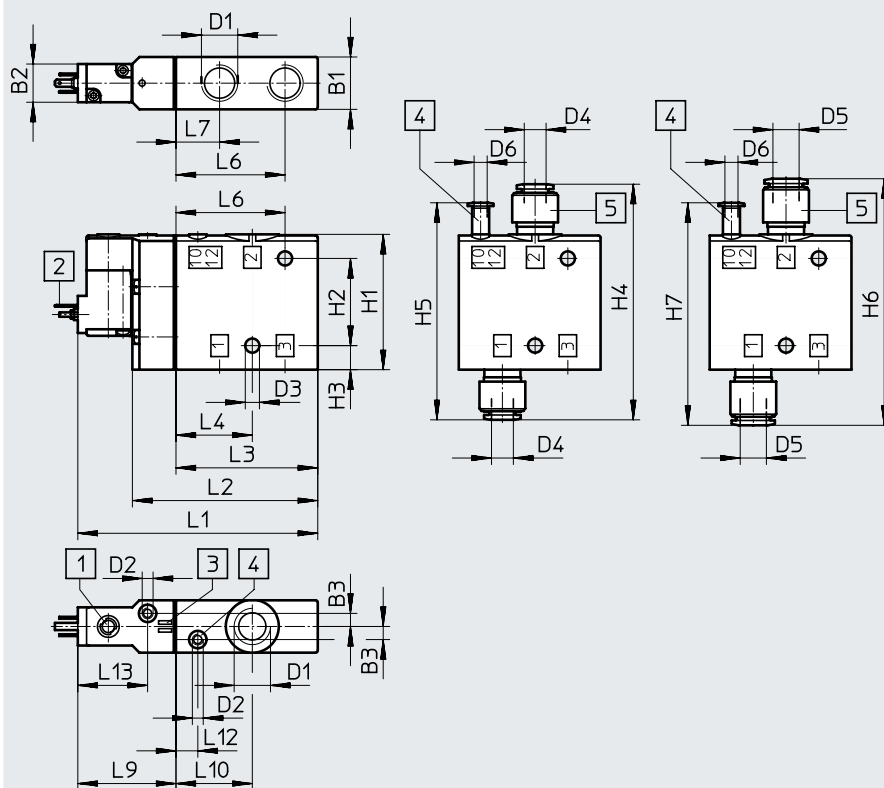

[1] Manual override  
[2] Plug type C, to EN 175301-803

[3] Space for inscription labels

[4] Port 10/12 for external pilot air supply

[5] QS push-in fitting

Type	B1 ±0.1	B2 -0.5	B3	D1	D2	D3 ∅	D4 ∅	D5 ∅	D6 ∅	H1 ±0.25	H2	H3 ±0.1	H4	H5	H6	H7
CPE24-M1H-3...	24	17.5	6	G3/8	M5	6.5	10	12	6	62	40	11	108	99.5	113	102

  

Type	L1	L2	L3 ±0.2	L4 ±0.12	L6 ±0.15	L7 ±0.12	L9	L10	L12 ±0.12	L13
CPE124-M1H-3...	110	85	65	35	50	20	45	35	10	32

Datasheet

Dimensions – 5/2-way single solenoid valve

Download CAD data → [www.festo.com](http://www.festo.com)

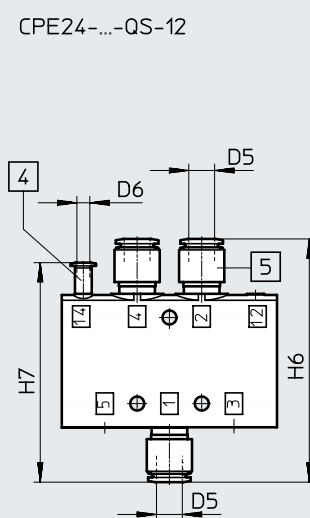
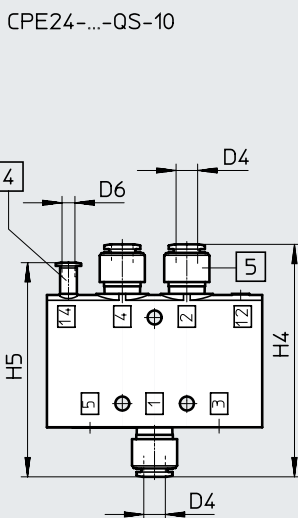
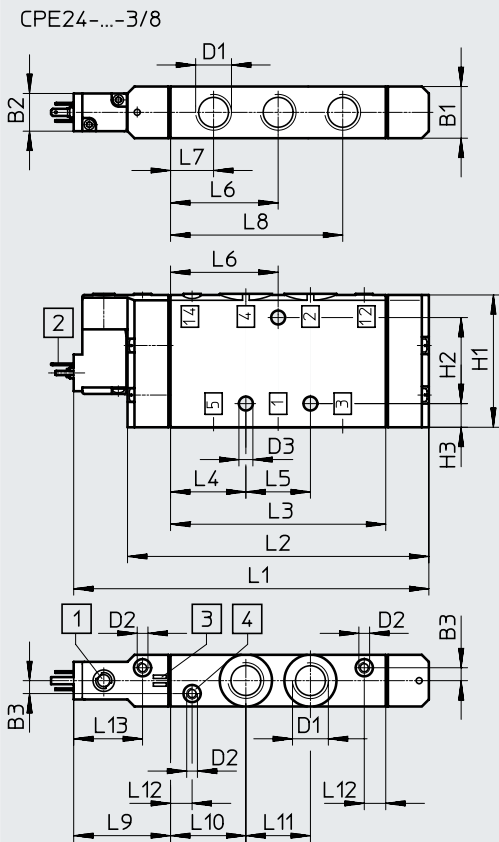

- [1] Manual override
- [2] Plug type C, to EN 175301-803
- [3] Space for inscription labels
- [4] Port 12/14 for external pilot air supply
- [5] QS push-in fitting

Type	B1	B2	B3	D1	D2	D3 ∅	D4 ∅	D5 ∅	D6 ∅	H1	H2	H3	H4	H5	H6	H7
CPE24-M1H-5L...	24	17.5	6	G3/8	M5	6.5	10	12	6	62	40	11	108	99.5	113	102

Type	L1	L2	L3	L4	L5	L6	L7	L8	L9	L10	L11	L12	L13
CPE24-M1H-5L...	165	140	100	35	30	50	20	80	45	35	30	10	32

Datasheet

Dimensions – 5/2-way double solenoid valve

Download CAD data → [www.festo.com](http://www.festo.com)

Threaded connection

Push-in connector

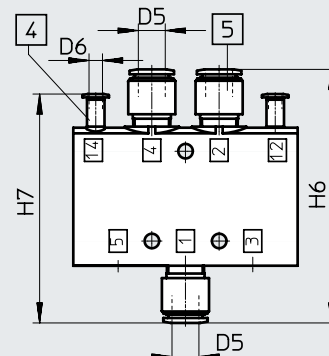
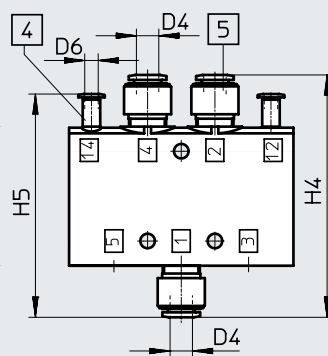
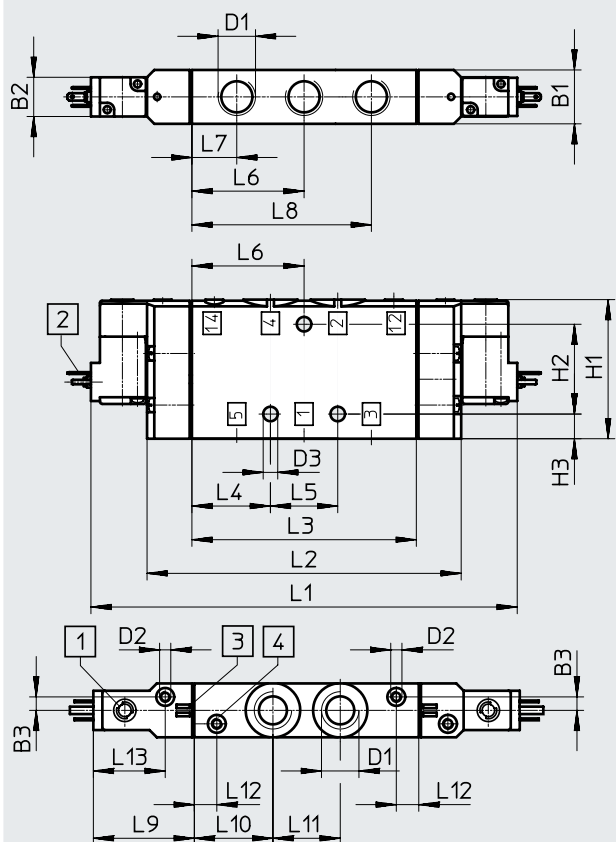

- [1] Manual override
- [2] Plug type C, to EN 175301-803
- [3] Space for inscription labels
- [4] Port 12/14 for external pilot air supply
- [5] QS push-in fitting

Type	B1	B2	B3	D1	D2	D3 ∅	D4 ∅	D5 ∅	D6 ∅	H1	H2	H3	H4	H5	H6	H7
CPE24-...-5)-3/8	24	17.5	6	G3/8	M5	6.5	10	12	6	62	40	11	108	99.5	113	102

Type	L1	L2	L3	L4	L5	L6	L7	L8	L9	L10	L11	L12	L13
CPE24-...-5)-3/8	190	140	100	35	30	50	20	80	45	35	30	10	32

Datasheet

Dimensions – 5/3-way valve

Download CAD data → [www.festo.com](http://www.festo.com)

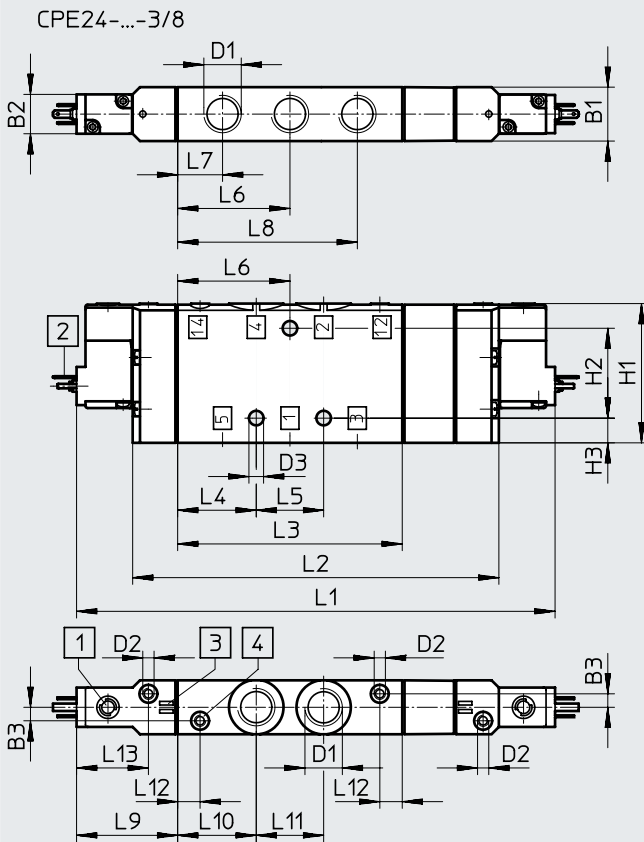

CPE24-...-QS-10

CPE24-...-QS-12

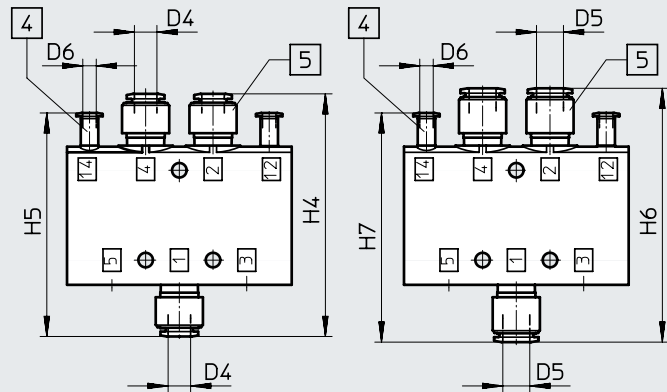

- [1] Manual override
- [2] Plug type C, to EN 175301-803
- [3] Space for inscription labels
- [4] Port 12/14 for external pilot air supply
- [5] QS push-in fitting

Type	B1 ±0.1	B2 -0.5	B3	D1	D2	D3 ∅	D4 ∅	D5 ∅	D6 ∅	H1 ±0.25	H2	H3 ±0.1	H4	H5	H6	H7
CPE24-M1H...-5	24	17.5	6	G3/8	M5	6.5	10	12	6	62	40	11	108	99.5	113	102
CPE24-M1H...-5/3																

Type	L1	L2	L3 ±0.2	L4 ±0.2	L5	L6	L7 ±0.12	L8 ±0.2	L9	L10 ±0.12	L11	L12 ±0.12	L13
CPE24-M1H...-5]	190	140	100	35	30	50	20	80	45	35	30	10	32
CPE24-M1H...-5/3	213	163											

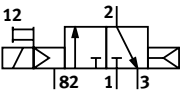
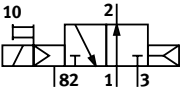
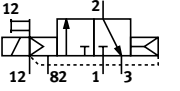
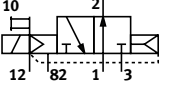

## Ordering data – 3/2-way valve

Ordering data Circuit symbol	Pilot air supply	Voltage	Pneumatic connection	Weight [g]	Part no.	Type	
<b>Normally closed</b>							
	Internal	24 V DC	G3/8	220	163165	CPE24-M1H-3GL-3/8	
			QS-10	–	163173	CPE24-M1H-3GL-QS-10	
			QS-12	–	163181	CPE24-M1H-3GL-QS-12	
		110 V AC	Internal	G3/8	220	163809	CPE24-M2H-3GL-3/8
				QS-10	–	163817	CPE24-M2H-3GL-QS-10
				QS-12	–	163825	CPE24-M2H-3GL-QS-12
		230 V AC	Internal	G3/8	220	163833	CPE24-M3H-3GL-3/8
				QS-10	–	163841	CPE24-M3H-3GL-QS-10
				QS-12	–	163849	CPE24-M3H-3GL-QS-12
<b>Normally open</b>							
	Internal	24 V DC	G3/8	220	163164	CPE24-M1H-3OL-3/8	
			QS-10	–	163172	CPE24-M1H-3OL-QS-10	
			QS-12	–	163180	CPE24-M1H-3OL-QS-12	
		110 V AC	Internal	G3/8	220	163808	CPE24-M2H-3OL-3/8
				QS-10	–	163816	CPE24-M2H-3OL-QS-10
				QS-12	–	163824	CPE24-M2H-3OL-QS-12
		230 V AC	Internal	G3/8	220	163832	CPE24-M3H-3OL-3/8
				QS-10	–	163840	CPE24-M3H-3OL-QS-10
				QS-12	–	163848	CPE24-M3H-3OL-QS-12
<b>Normally closed</b>							
	External	24 V DC	G3/8	220	163169	CPE24-M1H-3GLS-3/8	
			QS-10	–	163177	CPE24-M1H-3GLS-QS-10	
			QS-12	–	163185	CPE24-M1H-3GLS-QS-12	
		110 V AC	External	G3/8	220	163813	CPE24-M2H-3GLS-3/8
				QS-10	–	163821	CPE24-M2H-3GLS-QS-10
				QS-12	–	163829	CPE24-M2H-3GLS-QS-12
		230 V AC	External	G3/8	220	163837	CPE24-M3H-3GLS-3/8
				QS-10	–	163845	CPE24-M3H-3GLS-QS-10
				QS-12	–	163853	CPE24-M3H-3GLS-QS-12
<b>Normally open</b>							
	External	24 V DC	G3/8	220	163168	CPE24-M1H-3OLS-3/8	
			QS-10	–	163176	CPE24-M1H-3OLS-QS-10	
			QS-12	–	163184	CPE24-M1H-3OLS-QS-12	
		110 V AC	External	G3/8	220	163812	CPE24-M2H-3OLS-3/8
				QS-10	–	163820	CPE24-M2H-3OLS-QS-10
				QS-12	–	163828	CPE24-M2H-3OLS-QS-12
		230 V AC	External	G3/8	220	163836	CPE24-M3H-3OLS-3/8
				QS-10	–	163844	CPE24-M3H-3OLS-QS-10
				QS-12	–	163852	CPE24-M3H-3OLS-QS-12

Ordering data – 5/2-way valve

Ordering data Circuit symbol	Pilot air supply	Voltage	Pneumatic connection	Weight [g]	Part no.	Type
<b>5/2-way valve, single solenoid</b>						
	Internal	24 V DC	G3/8	360	163166	CPE24-M1H-5L-3/8
			QS-10	–	163174	CPE24-M1H-5L-QS-10
			QS-12	–	163182	CPE24-M1H-5L-QS-12
		110 V AC	G3/8	360	163810	CPE24-M2H-5L-3/8
				–	163818	CPE24-M2H-5L-QS-10
				–	163826	CPE24-M2H-5L-QS-12
		230 V AC	G3/8	360	163834	CPE24-M3H-5L-3/8
				–	163842	CPE24-M3H-5L-QS-10
				–	163850	CPE24-M3H-5L-QS-12
<b>5/2-way double pilot valve</b>						
	Internal	24 V DC	G3/8	390	163167	CPE24-M1H-5J-3/8
			QS-10	–	163175	CPE24-M1H-5J-QS-10
			QS-12	–	163183	CPE24-M1H-5J-QS-12
		110 V AC	G3/8	390	163811	CPE24-M2H-5J-3/8
				–	163819	CPE24-M2H-5J-QS-10
				–	163827	CPE24-M2H-5J-QS-12
		230 V AC	G3/8	390	163835	CPE24-M3H-5J-3/8
				–	163843	CPE24-M3H-5J-QS-10
				–	163851	CPE24-M3H-5J-QS-12
<b>5/2-way valve, single solenoid</b>						
	External	24 V DC	G3/8	360	163170	CPE24-M1H-5LS-3/8
			QS-10	–	163178	CPE24-M1H-5LS-QS-10
			QS-12	–	163186	CPE24-M1H-5LS-QS-12
		110 V AC	G3/8	360	163814	CPE24-M2H-5LS-3/8
				–	163822	CPE24-M2H-5LS-QS-10
				–	163830	CPE24-M2H-5LS-QS-12
		230 V AC	G3/8	360	163838	CPE24-M3H-5LS-3/8
				–	163846	CPE24-M3H-5LS-QS-10
				–	163854	CPE24-M3H-5LS-QS-12
<b>5/2-way double pilot valve</b>						
	External	24 V DC	G3/8	390	163171	CPE24-M1H-5JS-3/8
			QS-10	–	163179	CPE24-M1H-5JS-QS-10
			QS-12	–	163187	CPE24-M1H-5JS-QS-12
		110 V AC	G3/8	390	163815	CPE24-M2H-5JS-3/8
				–	163823	CPE24-M2H-5JS-QS-10
				–	163831	CPE24-M2H-5JS-QS-12
		230 V AC	G3/8	390	163839	CPE24-M3H-5JS-3/8
				–	163847	CPE24-M3H-5JS-QS-10
				–	163855	CPE24-M3H-5JS-QS-12



## Ordering data – 5/3-way valve

Ordering data						
Circuit symbol	Pilot air supply	Voltage	Pneumatic connection	Weight [g]	Part no.	Type
<b>5/3-way mid-position valve, normally closed</b>						
	Internal	24 V DC	G3/8	430	170265	CPE24-M1H-5/3G-3/8
			QS-10	–	170271	CPE24-M1H-5/3G-QS-10
			QS-12	–	170277	CPE24-M1H-5/3G-QS-12
		110 V AC	G3/8	430	170301	CPE24-M2H-5/3G-3/8
			QS-10	–	170307	CPE24-M2H-5/3G-QS-10
			QS-12	–	170313	CPE24-M2H-5/3G-QS-12
		230 V AC	G3/8	430	170337	CPE24-M3H-5/3G-3/8
			QS-10	–	170343	CPE24-M3H-5/3G-QS-10
			QS-12	–	170349	CPE24-M3H-5/3G-QS-12
<b>5/3-way mid-position valve, normally exhausted</b>						
	Internal	24 V DC	G3/8	430	170267	CPE24-M1H-5/3E-3/8
			QS-10	–	170273	CPE24-M1H-5/3E-QS-10
			QS-12	–	170279	CPE24-M1H-5/3E-QS-12
		110 V AC	G3/8	430	170303	CPE24-M2H-5/3E-3/8
			QS-10	–	170309	CPE24-M2H-5/3E-QS-10
			QS-12	–	170315	CPE24-M2H-5/3E-QS-12
		230 V AC	G3/8	430	170339	CPE24-M3H-5/3E-3/8
			QS-10	–	170345	CPE24-M3H-5/3E-QS-10
			QS-12	–	170351	CPE24-M3H-5/3E-QS-12
<b>5/3-way mid-position valve, normally open</b>						
	Internal	24 V DC	G3/8	430	170269	CPE24-M1H-5/3B-3/8
			QS-10	–	170275	CPE24-M1H-5/3B-QS-10
			QS-12	–	170281	CPE24-M1H-5/3B-QS-12
		110 V AC	G3/8	430	170305	CPE24-M2H-5/3B-3/8
			QS-10	–	170311	CPE24-M2H-5/3B-QS-10
			QS-12	–	170317	CPE24-M2H-5/3B-QS-12
		230 V AC	G3/8	430	170341	CPE24-M3H-5/3B-3/8
			QS-10	–	170347	CPE24-M3H-5/3B-QS-10
			QS-12	–	170353	CPE24-M3H-5/3B-QS-12





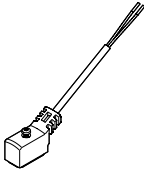
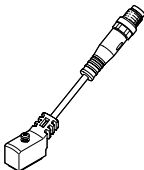
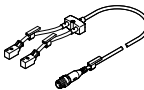

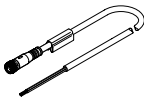

Ordering data – 5/3-way valves

Ordering data – 5/3-way valve Circuit symbol	Pilot air supply	Voltage	Pneumatic connection	Weight [g]	Part no.	Type
<b>5/3-way mid-position valve, normally closed</b>						
	External	24 V DC	G3/8	430	<b>170266</b>	CPE24-M1H-5/3GS-3/8
			QS-10	–	<b>170272</b>	CPE24-M1H-5/3GS-QS-10
			QS-12	–	<b>170278</b>	CPE24-M1H-5/3GS-QS-12
		110 V AC	G3/8	430	<b>170302</b>	CPE24-M2H-5/3GS-3/8
			QS-10	–	<b>170308</b>	CPE24-M2H-5/3GS-QS-10
			QS-12	–	<b>170314</b>	CPE24-M2H-5/3GS-QS-12
		230 V AC	G3/8	430	<b>170338</b>	CPE24-M3H-5/3GS-3/8
			QS-10	–	<b>170344</b>	CPE24-M3H-5/3GS-QS-10
			QS-12	–	<b>170350</b>	CPE24-M3H-5/3GS-QS-12
<b>5/3-way mid-position valve, normally exhausted</b>						
	External	24 V DC	G3/8	430	<b>170268</b>	CPE24-M1H-5/3ES-3/8
			QS-10	–	<b>170274</b>	CPE24-M1H-5/3ES-QS-10
			QS-12	–	<b>170280</b>	CPE24-M1H-5/3ES-QS-12
		110 V AC	G3/8	430	<b>170304</b>	CPE24-M2H-5/3ES-3/8
			QS-10	–	<b>170310</b>	CPE24-M2H-5/3ES-QS-10
			QS-12	–	<b>170316</b>	CPE24-M2H-5/3ES-QS-12
		230 V AC	G3/8	430	<b>170340</b>	CPE24-M3H-5/3ES-3/8
			QS-10	–	<b>170346</b>	CPE24-M3H-5/3ES-QS-10
			QS-12	–	<b>170352</b>	CPE24-M3H-5/3ES-QS-12
<b>5/3-way mid-position valve, normally open</b>						
	External	24 V DC	G3/8	430	<b>170270</b>	CPE24-M1H-5/3BS-3/8
			QS-10	–	<b>170276</b>	CPE24-M1H-5/3BS-QS-10
			QS-12	–	<b>170282</b>	CPE24-M1H-5/3BS-QS-12
		110 V AC	G3/8	430	<b>170306</b>	CPE24-M2H-5/3BS-3/8
			QS-10	–	<b>170312</b>	CPE24-M2H-5/3BS-QS-10
			QS-12	–	<b>170318</b>	CPE24-M2H-5/3BS-QS-12
		230 V AC	G3/8	430	<b>170342</b>	CPE24-M3H-5/3BS-3/8
			QS-10	–	<b>170348</b>	CPE24-M3H-5/3BS-QS-10
			QS-12	–	<b>170354</b>	CPE24-M3H-5/3BS-QS-12

## Accessories

Ordering data – Accessories for CPE10 and CPE14					Part no.	Type	
<b>Connecting cable, socket plug pattern ZC</b>					Datasheets → Internet: nebv		
	Open cable end 2-wire	PUR cable, degree of protection IP65	Holding current reduction, protective circuit, signal status indication with LED	Length 2.5 m	<b>8047679</b>	<b>NEBV-Z4WA2L-R-E-2.5-N-LE2-S1</b>	
				Length 5 m	<b>8047680</b>	<b>NEBV-Z4WA2L-R-E-5-N-LE2-S1</b>	
				Length 10 m	<b>8047678</b>	<b>NEBV-Z4WA2L-R-E-10-N-LE2-S1</b>	
		PVC cable, degree of protection IP40	Without signal status indication	Length 0.5 m	<b>193690</b>	<b>KMYZ-4-24-0.5-B</b>	
Length 2.5 m				<b>193691</b>	<b>KMYZ-4-24-2.5-B</b>		
	Plug M8x1 3-pin	PUR cable, degree of protection IP65	Holding current reduction, protective circuit, signal status indication with LED	Length 0.5 m	<b>8047683</b>	<b>NEBV-Z4WA2L-R-E-0.5-N-M8G3-S1</b>	
				Length 2.5 m	<b>8047684</b>	<b>NEBV-Z4WA2L-R-E-2.5-N-M8G3-S1</b>	
<b>2 to 1 distributor</b>					Datasheet → Internet: neby		
	2x plug socket plug pattern ZC	Holding current reduction, protective circuit, signal status indication with LED	1x plug, straight, M8x1	Length 2.8 m	<b>8035789</b>	<b>NEDY-L2R1-V1-Z4W2Z-U-0.3L-M8G4-2.5R</b>	
			1x plug, straight, M12x1	Length 5.3 m	<b>8035790</b>	<b>NEDY-L2R1-V1-Z4W2Z-U-0.3L-M8G4-5R</b>	
	Modular system for any 2 to 1 distributor				Length 2.8 m	<b>8035787</b>	<b>NEDY-L2R1-V1-Z4W2Z-U-0.3L-M12G4-2.5R</b>
					Length 5.3 m	<b>8035788</b>	<b>NEDY-L2R1-V1-Z4W2Z-U-0.3L-M12G4-5R</b>
				Length 0.3 ... 30 m	<b>8032867</b>	<b>NEBY-...</b> → Internet: nedy	
<b>Adapter</b>							
	Plug socket, plug pattern ZC	Signal status indication with LED	Plug M8, 3-pin	<b>571686</b>	<b>VAVE-C8-1R8</b>		
			Plug M8, 4-pin	<b>573194</b>	<b>VAVE-C8-1R1</b>		
<b>Connecting cable, socket M8x1</b>					Datasheet → Internet: nebu		
	Socket M8x1, 3-pin	Straight	Open cable end 3-wire	Length 2.5 m	<b>541333</b>	<b>NEBU-M8G3-K-2.5-LE3</b>	
				Length 5 m	<b>541334</b>	<b>NEBU-M8G3-K-5-LE3</b>	
		Plug M8x1, 3-pin			Length 2.5 m	<b>541348</b>	<b>NEBU-M8G3-K-2.5-M8G3</b>
					Length 5 m	<b>541349</b>	<b>NEBU-M8G3-K-5-M8G3</b>
		Angled	Open cable end 3-wire	Length 10 m	<b>569844</b>	<b>NEBU-M8G3-K-10-M8G3</b>	
				Length 2.5 m	<b>541338</b>	<b>NEBU-M8W3-K-2.5-LE3</b>	
	Socket M8x1, 4-pin	Straight	Open cable end 4-wire	Length 5 m	<b>541341</b>	<b>NEBU-M8W3-K-5-LE3</b>	
				Length 2.5 m	<b>541342</b>	<b>NEBU-M8G4-K-2.5-LE4</b>	
		Angled	Open cable end 4-wire	Length 5 m	<b>541343</b>	<b>NEBU-M8G4-K-5-LE4</b>	
				Length 2.5 m	<b>541345</b>	<b>NEBU-M8W4-K-5-LE4</b>	
			Length 2.5 m	<b>541344</b>	<b>NEBU-M8W4-K-2.5-LE4</b>		
		Modular system for a choice of connecting cables	Length 0.1 ... 30 m	<b>539052</b>	<b>NEBU-...</b> → Internet: nebu		

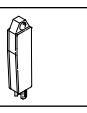
Accessories

Ordering data – Accessories for CPE18 and CPE24					Part no.	Type		
<b>Plug socket with cable, socket type C to EN 175301-803</b>					Datasheet → Internet: kmeb			
	Cable sheath PVC	Signal status indication with LED	24 V DC	Length 2.5 m	151688	KMEB-1-24-2.5-LED		
			24 V DC	Length 5 m	151689	KMEB-1-24-5-LED		
			24 V DC	Length 10 m	193457	KMEB-1-24-10-LED		
		Without indication	Up to 240 V	Length 2.5 m	151690	KMEB-1-230-2.5		
Up to 240 V	Length 5 m		151691	KMEB-1-230-5				
	Cable sheath PUR	Signal status indication with LED	24 V DC	Length 2.5 m	174844	KMEB-2-24-2.5-LED		
			24 V DC	Length 5 m	174845	KMEB-2-24-5-LED		
		Without indication	Up to 240 V	Length 2.5 m	174846	KMEB-2-230-2.5		
			Up to 240 V	Length 5 m	174847	KMEB-2-230-5		
<b>Plug socket</b>					Datasheet → Internet: mssd			
	Socket 3-pin, type C to EN 175301-803	Screw terminal	Up to 240 V	151687	MSSD-EB			
		Insulation displacement connector	Up to 240 V	539712	MSSD-EB-M12			
			Up to 240 V	192745	MSSD-EB-S-M14			
<b>Illuminating seal</b>					Datasheets → Internet: meb-ld			
	Type C to EN 175301-803	12 ... 24 V DC	151717	MEB-LD-12-24DC				
		230 V AC	151718	MEB-LD-230AC				
<b>Ordering data – General accessories</b>					Part no.	Type	PU <sup>1)</sup>	
<b>Blanking plug</b>					Datasheet → Internet: b			
	For manifold block CPE10	G1/4 thread	3569	B-1/4	10			
	For manifold block CPE14, CPE18	G3/8 thread	3570	B-3/8	10			
<b>Separator for pressure zones</b>					Datasheet → Internet: vabd			
	For manifold block CPE14, CPE18		160997	PRSV-1/8	1			
<b>Silencer</b>					Datasheet → Internet: uc			
	Thread	M3	1231120	AMTE-M-LH-M3	20			
		M5	165003	UC-M5	1			
		M7	161418	UC-M7	1			
		G1/8	161419	UC-1/8	1			
		G1/4	165004	UC-1/4	1			
<b>Manual override</b>					Datasheet → Internet: ahb			
	For CPE10 and CPE14 with plug pattern ZC		157600	AHB-MZB	1			
	For CPE18 and CPE24 with plug type C		157601	AHB-MEB	1			
<b>Inscription labels</b>					Datasheet → Internet: ibs			
	Inscription label, 6x10 mm		18576	IBS-6x10	64			
<b>Mounting kit</b>					Datasheet → Internet: davm			
	With mounting bracket for lateral valve mounting	For standards-based cylinders DSBC-32...40	For CPE14	2568514	DAVM-MW-V1-32-V	1		
		For standards-based cylinders DSBC-50...125	For CPE18, CPE24	2612128	DAVM-MW-V1-50-V	1		

1) Packaging unit.