



# DIAPHRAGM PUMPS



CE Made in Italy

DESIGNED AND MANUFACTURED  
AT **ECODORA** - ITALY



n° **2011/4-M**

**FLUID TRANSFER EQUIPMENT**



# INSTALLATION AND OPERATION

## ► SIMPLE AND EFFECTIVE (1:1 RATIO)

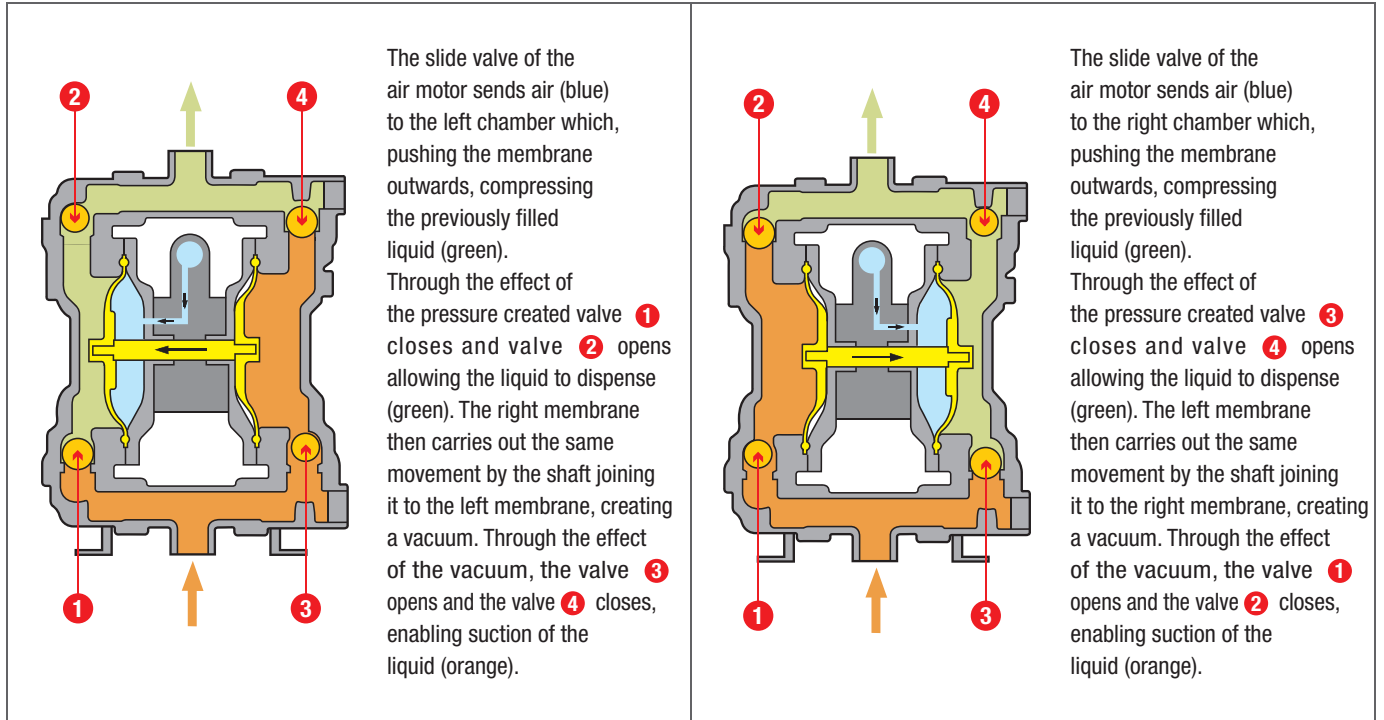

## ► HOW TO INSTALL THE PUMP

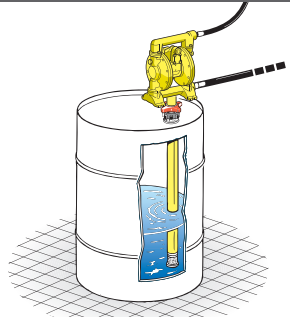
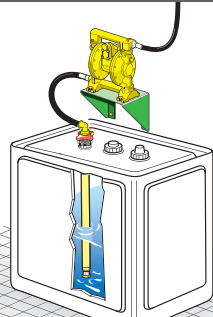
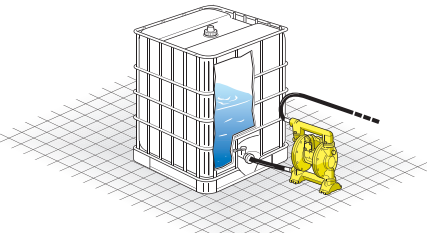
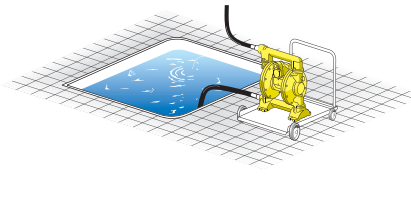
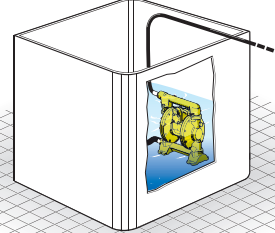
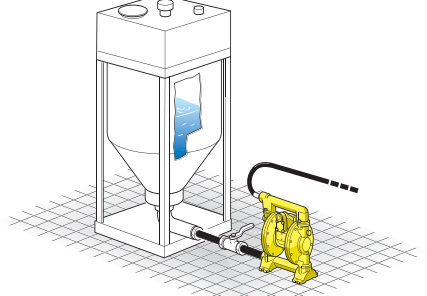
<p><b>PUMP INSTALLED ABOVE 200 l DRUM</b> (with special bung adaptor)</p>	<p><b>SELF PRIMING PUMP INSTALLED ABOVE HEAD (NEGATIVE SUCTION)</b> (pump may initially work with dry column without problem)</p>	<p><b>PUMP INSTALLED BELOW HEAD (POSITIVE SUCTION)</b> (when it is necessary to empty completely the container)</p>
		
<p><b>PUMP INSTALLED ON A MOBILE UNIT</b> (with a trolley or cart when pump must be often moved)</p>	<p><b>SUBMERGED PUMP</b> (it is necessary to check the chemical compatibility between pump material and liquid)</p>	<p><b>PUMP INSTALLED ON HOPPER FOR HIGH VISCOSITY LIQUID</b> (hopper's height and liquid density influence inlet pressure on the pump which must be not greater than 0.7 bar)</p>
		

# PUMP CONFIGURATION

Exploded view of the pump, showing its main parts and thereby facilitating the choice for a custom configuration.

The table summarises the pump configurations available, allowing the user to create his own personalised code whenever the models listed on the leaflet do not meet the specific requirements.

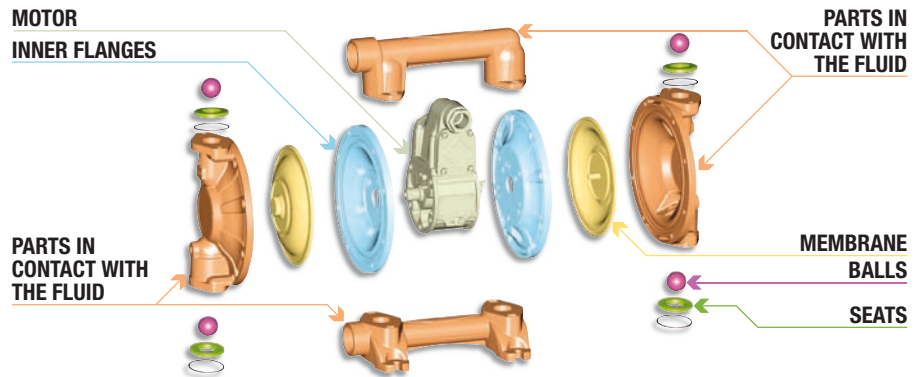

Two types of ATEX certifications are available, for zone 2 or for zone 1, depending on the materials making up the pump.

II 3GD T4 cIIB X (for zone 2)    II 2GD T4 cIIB X (for zone 1)

The valve seats are to be coupled to the balls and must ensure correct closing. Like the balls, they must be made from a material suitable for the fluid they come into contact with.

They open and close the flow of liquid as a result of the reciprocating movement of the follower plates. The material they are made from must be compatible with the fluid being pumped.

They can be threaded (BSP) or flanged, single, multiple and modular.

They are the only elastic parts of the pump, that suck and pump the liquid with their movement. The material they are made from must be selected in order to obtain the correct chemical compatibility with the liquid to be pumped.

Defines the inside diameter of the manifold.

These are all the rigid parts such as external flanges, manifolds and sleeves which are constantly in contact with the liquid to be pumped. Available in various materials, depending on the type of liquid.

This is the heart of the pump, responsible for the reciprocating movement that create the flow of liquid.

These are not in contact with the pumped liquid, but only with the compressed air feeding the motor.

MATERIALS AND ATEX VERSIONS	MANIFOLD FOR INLET AND OUTLET	FLOW INSIDE DIAMETER	KIND OF MATERIALS					
			MOTOR	INNER FLANGES	PARTS IN CONTACT WITH THE FLUID	MEMBRANE	BALLS	SEATS
OA2B = plastic for Zone 2	1 = BSP threaded connection	16 = 1/2"	1 = nichel plat. aluminium	1 = nichel plat. aluminium	1 = nichel plated aluminium	E = EPDM	A = acetalic	A = acetalic
OA3C = aluminium for Zone 1	3 = mult. BSP threaded con.	26 = 1"				H = hytel	H = hytel	H = hytel
	4 = connection with flange	30 = 1.1/4"			7 = polypropylene	N = NBR	S = santoprene	P = polypropylene
	6 = multiple modular connection with flange	40 = 1.1/2"				S = santoprene	T = PTFE	S = santoprene
	7 = dual inlet connection with flange	50 = 2"				T = PTFE + hytel		1 = cylindrical acetalic
	8 = dual inlet BSP threaded connection							2 = cylindrical polypropylene

EXAMPLE **OA3C116111EAA**

OA3C = aluminium for Zone 1	1 = BSP threaded connection	16 = 1/2"	1 = nichel plat. aluminium	1 = nichel plat. aluminium	1 = nichel plated aluminium	E = EPDM	A = acetalic	A = acetalic
-----------------------------	-----------------------------	-----------	----------------------------	----------------------------	-----------------------------	----------	--------------	--------------



## DESIGN

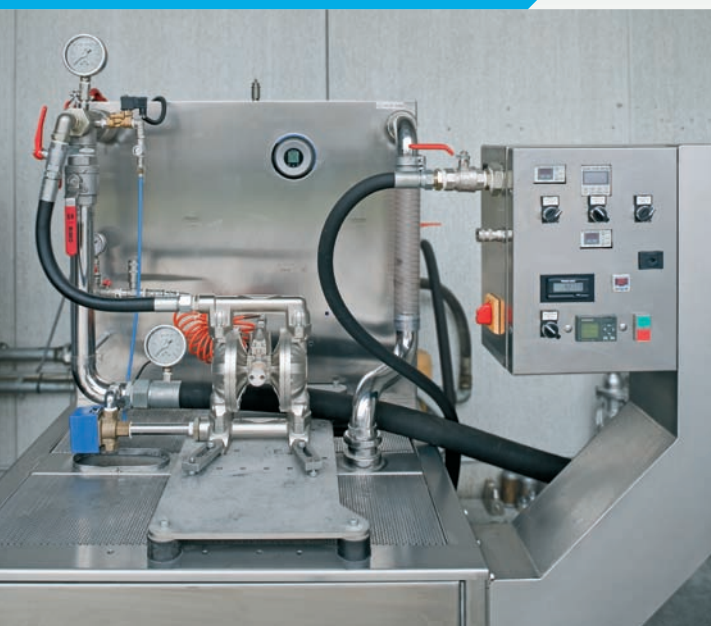

## GLOBAL TEST





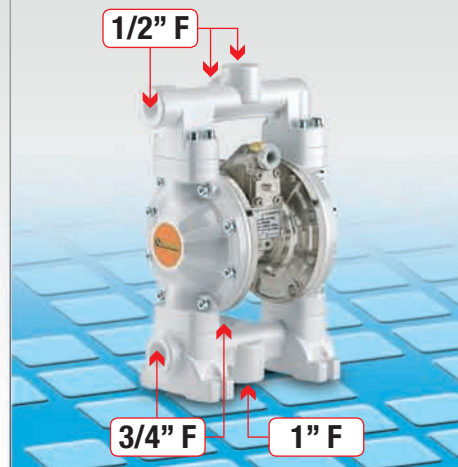

## ASSEMBLING

**Diaphragm pumps R. 1:1 for transfer industrial fluids compatible with the materials of the pumps,** made from die-cast aluminium or molding injected Polypropylene, with high quality components, they ensure lasting and reliable operation even in extreme conditions.

**1/2" -**



**Note:** The max flow rate shown in the below graphics has been obtained by laboratory test.

Series		120-PB in Polypropylene - motor Aluminium	
membrane	EPDM	Art. 0E2B3/16117EA1	membrane EPDM
	Hytrel	Art. 0E2B3/16117HH2	" Hytrel
	NBR	Art. 0E2B3/16117NH2	" NBR
	Santoprene	Art. 0E2B3/16117SS2	" Santoprene
	PTFE+Hytrel ***	Art. 0E2B3/16117TT2	" PTFE+Hytrel
			
Max. pressure	8 bar		
Max cycles per min	330 cpm		
Litres per cycle *	0,18 l		
Max suction lift	dry column 4,5 m - wet column 7,5 m		
Max size pumpable solids	1,5 mm		
Max working temperature	65° C		
Noise level **	75 dB		
Max air consumption (m <sup>3</sup> /min)	0,50 m <sup>3</sup> /min		
Air working pressure	2 - 6 bar		
Air inlet connection	F 3/8" G		
Air outlet connection (muffler)	F 1/2" G		
Fluid inlet connection	F 3/4" G (F 1" G for drum)		
Fluid outlet connection	F 1/2" G		
Balls for inlet and outlet			
Overall dimensions (A x B x C)	218 mm x 178,2 mm x 326 mm		
Packing - Weight	 N° 1 packing m <sup>3</sup> 0,014  Kg 7		

\* Displacement per cycle may be influenced by suction lift, fluid viscosity, air pressure, number of

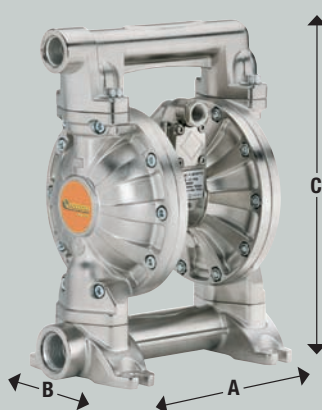

PUMP AIR FEEDING PRESSURE

- A** 8 bar (116 psi)
- B** 6 bar (87 psi)
- C** 4 bar (58 psi)



■ KIND OF FLUID  
■ SAE30 oil: (IS)

60 l/min

1" - 170 l/min



WITH FLANGE 1"



WITH FLANGE 1"



WITH FLANGE 1"

WITH FLANGE 1"

<b>120-PB</b> in Polypropylene - motor Aluminium		<b>1000-PB</b> in Polypropylene - motor Aluminium		<b>1000-PB</b> in Polypropylene - motor Aluminium	
---	--	--	--	--	--

Art. 0E2B8/16117EA1	membrane EPDM	Art. 0E2B4/26117EAA	membrane EPDM	Art. 0E2B7/26117EAA	membrane EPDM
Art. 0E2B8/16117HH2	" Hytrel	Art. 0E2B4/26117HHH	" Hytrel	Art. 0E2B7/26117HHH	" Hytrel
Art. 0E2B8/16117NH2	" NBR	Art. 0E2B4/26117NHH	" NBR	Art. 0E2B7/26117NHH	" NBR
Art. 0E2B8/16117SS2	" Santoprene	Art. 0E2B4/26117SSS	" Santoprene	Art. 0E2B7/26117SSS	" Santoprene
Art. 0E2B8/16117TT2	" PTFE+Hytrel	Art. 0E2B4/26117TTP	" PTFE+Hytrel	Art. 0E2B7/26117TTP	" PTFE+Hytrel

8 bar	8 bar	8 bar
330 cpm	300 cpm	300 cpm
0,18 l	0,59 l	0,59 l
dry column 4,5 m - wet column 7,5 m	dry column 5 m - wet column 7,5 m	dry column 5 m - wet column 7,5 m
1,5 mm	3 mm	3 mm
65° C	65° C	65° C
75 dB	75 dB	75 dB
0,50 m³/min	1,6 m³/min	1,6 m³/min
2 - 6 bar	2 - 6 bar	2 - 6 bar
F 3/8" G	F 3/8" G	F 3/8" G
F 1/2" G	F 1/2" G	F 1/2" G
<b>dual inlet F 3/4" G</b>	ANSI 150 - DIN PN 10 - JIS 10K 1" (25 mm) proneness to 1.1/4" thread	<b>dual inlet</b> ANSI 150 - DIN PN 10 - JIS 10K 1" (25 mm) proneness to 1.1/4" thread
F 1/2" G	ANSI 150 - DIN PN 10 - JIS 10K 1" (25 mm) proneness to 1.1/4" thread	ANSI 150 - DIN PN 10 - JIS 10K 1" (25 mm) proneness to 1.1/4" thread

220 mm x 178,2 mm x 327 mm	300 mm x 200 mm x 430 mm	357 mm x 198,12 mm x 418,2 mm
📦 N° 1 packing m³ 0,014 📦 Kg 7	📦 N° 1 packing m³ 0,025 📦 Kg 12	📦 N° 1 packing m³ 0,025 📦 Kg 12

cycles per minute      \*\* Different kind of muffler are available on request for special use or hard work      \*\*\* With PTFE membrane flow rate is 10 % lower

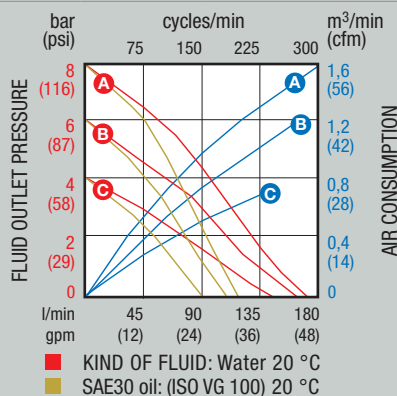
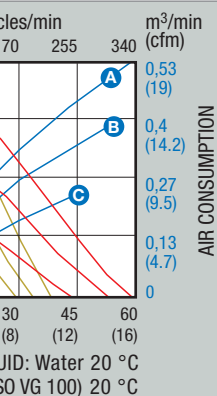

**1/2" - 70 l/min**

**1" - 170 l/min**

**1.1/4" - 200 l/min**

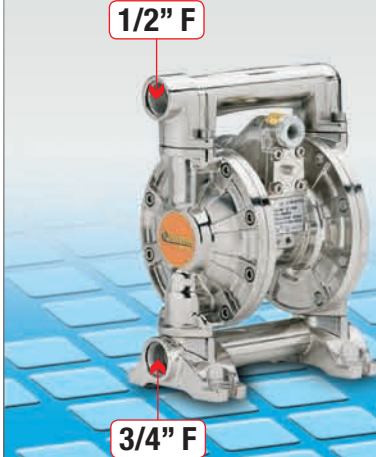

**120-AB**  
all Aluminium

**1000-AB**  
all Aluminium

**1140-AB**  
all Aluminium

Art. <b>0E3C1/16111EAA</b>	membrane <b>EPDM</b>
Art. <b>0E3C1/16111HHH</b>	" <b>Hytrel</b>
Art. <b>0E3C1/16111NHH</b>	" <b>NBR</b>
Art. <b>0E3C1/16111SSS</b>	" <b>Santoprene</b>
Art. <b>0E3C1/16111TTP</b>	" <b>PTFE+Hytrel</b>

Art. <b>0E3C1/26111EAA</b>	membrane <b>EPDM</b>
Art. <b>0E3C1/26111HHH</b>	" <b>Hytrel</b>
Art. <b>0E3C1/26111NHH</b>	" <b>NBR</b>
Art. <b>0E3C1/26111SSS</b>	" <b>Santoprene</b>
Art. <b>0E3C1/26111TTP</b>	" <b>PTFE+Hytrel</b>

Art. <b>0E3C1/30111EAA</b>	membrane <b>EPDM</b>
Art. <b>0E3C1/30111HHH</b>	" <b>Hytrel</b>
Art. <b>0E3C1/30111NHH</b>	" <b>NBR</b>
Art. <b>0E3C1/30111SSS</b>	" <b>Santoprene</b>
Art. <b>0E3C1/30111TTP</b>	" <b>PTFE+Hytrel</b>

8 bar
400 cpm
0,18 l
dry column 4,5 m - wet column 7,5 m
1,5 mm
100° C
75 dB
0,60 m <sup>3</sup> /min
2 - 6 bar
F 3/8" G
F 1/2" G
F 3/4" G
F 1/2" G

8 bar
300 cpm
0,59 l
dry column 5 m - wet column 7,5 m
3 mm
100° C
75 dB
1,6 m <sup>3</sup> /min
2 - 6 bar
F 3/8" G
F 1/2" G
F 1.1/4" G
F 1" G

8 bar
260 cpm
0,8 l
dry column 5 m - wet column 7,5 m
3 mm
100° C
75 dB
1,8 m <sup>3</sup> /min
2 - 6 bar
F 3/4" G
F 1" G
F 1.1/4" G
F 1.1/4" G

201 mm x 160 mm x 256 mm  
 N° 1 packing m<sup>3</sup> 0,014    Kg 8

260,5 mm x 201 mm x 345 mm  
 N° 1 packing m<sup>3</sup> 0,025    Kg 13,5

286 mm x 238 mm x 386 mm  
 N° 1 packing m<sup>3</sup> 0,038    Kg 19

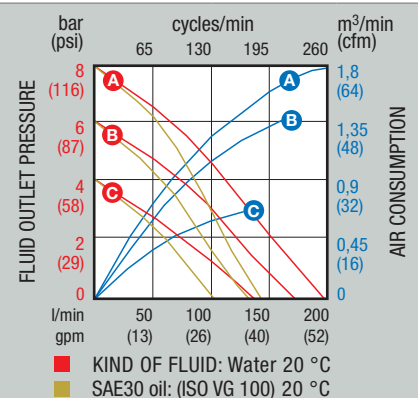
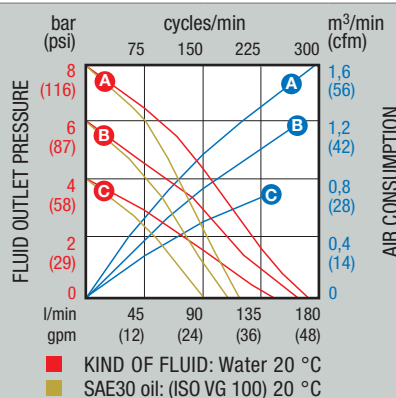
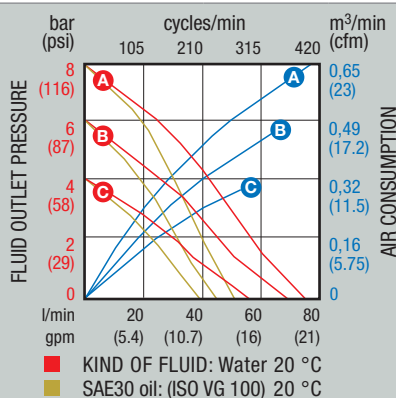

# 1.1/2" - 480 l/min

# 2" - 610 l/min

# 2" - 580 l/min

1.1/2" F



2" F

2" F



2.1/2" F

MODULAR WITH FLANGE 2"



MODULAR WITH FLANGE 2"

**1120-AB**  
all Aluminium

**2000-AB**  
all Aluminium

**2000-AB**  
all Aluminium

Art. <b>0E3C1/40111EAA</b>	membrane <b>EPDM</b>	Art. <b>0E3C1/50111EAA</b>	membrane <b>EPDM</b>	Art. <b>0E3C6/50111EAA</b>	membrane <b>EPDM</b>
Art. <b>0E3C1/40111HHH</b>	" <b>Hytrel</b>	Art. <b>0E3C1/50111HHH</b>	" <b>Hytrel</b>	Art. <b>0E3C6/50111HHH</b>	" <b>Hytrel</b>
Art. <b>0E3C1/40111NHH</b>	" <b>NBR</b>	Art. <b>0E3C1/50111NHH</b>	" <b>NBR</b>	Art. <b>0E3C6/50111NHH</b>	" <b>NBR</b>
Art. <b>0E3C1/40111SSS</b>	" <b>Santoprene</b>	Art. <b>0E3C1/50111SSS</b>	" <b>Santoprene</b>	Art. <b>0E3C6/50111SSS</b>	" <b>Santoprene</b>
Art. <b>0E3C1/40111TTP</b>	" <b>PTFE+Hytrel</b>	Art. <b>0E3C1/50111TTP</b>	" <b>PTFE+Hytrel</b>	Art. <b>0E3C6/50111TTP</b>	" <b>PTFE+Hytrel</b>

8 bar	8 bar	8 bar
220 cpm	147 cpm	147 cpm
2,15 l	4,15 l	3,95 l
dry column 5 m - wet column 7,5 m	dry column 5 m - wet column 7,5 m	dry column 5 m - wet column 7,5 m
5,5 mm	6,5 mm	6,5 mm
100° C	100° C	100° C
78 dB	82 dB	82 dB
3,4 m <sup>3</sup> /min	4 m <sup>3</sup> /min	4 m <sup>3</sup> /min
2 - 6 bar	2 - 6 bar	2 - 6 bar
F 3/4" G	F 3/4" G	F 3/4" G
F 1" G	F 1" G	F 1" G
F 2" G	F 2.1/2" G	ANSI 150 - DIN PN 10 - JIS 10K 2" (50 mm)
F 1.1/2" G	F 2" G	ANSI 150 - DIN PN 10 - JIS 10K 2" (50 mm)
350 mm x 402 mm x 514 mm	426,2 mm x 432 mm x 616 mm	409 mm x 432 mm x 709 mm
N° 1 packing m <sup>3</sup> 0,066    Kg 25,5	N° 1 packing m <sup>3</sup> 0,16    Kg 43	N° 1 packing m <sup>3</sup> 0,16    Kg 50

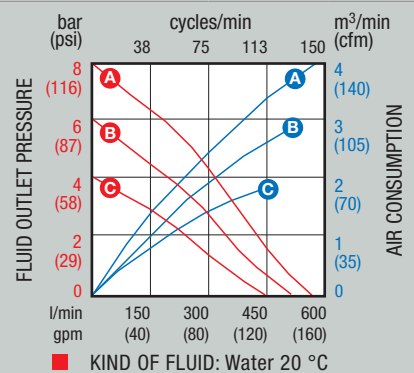
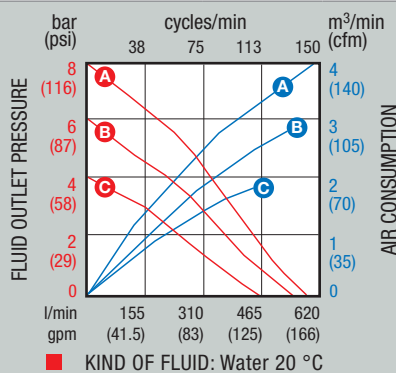
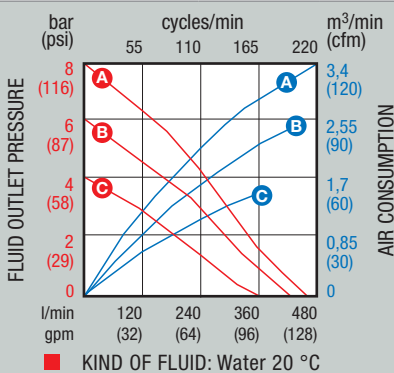

# IDEAL FOR ANY **INDUSTRY**

- GLASS INDUSTRY
- CHEMICAL INDUSTRY
- SHIPYARD
- SEMICONDUCTOR INDUSTRY
- PAINT INDUSTRY
- PRINT INDUSTRY
- FOOD INDUSTRY
- PETROCHEMISTRY
- MINING AND BUILDING CONSTRUCTIONS
- PHARMACEUTICS INDUSTRY
- MOTOR INDUSTRY
- PAPER MILL
- TEXTILE INDUSTRY
- CERAMIC INDUSTRY
- ELECTRONIC INDUSTRY



Authorized distributor



**ECODORA S.r.l.**

Tel. +39 0424 570891  
Fax +39 0424 571354

info@ecodora.com  
www.ecodora.com