

Drosselrückschlagventil

Unidirectional Flow Regulator

Regolatore di flusso unidirezionale in linea F.F.

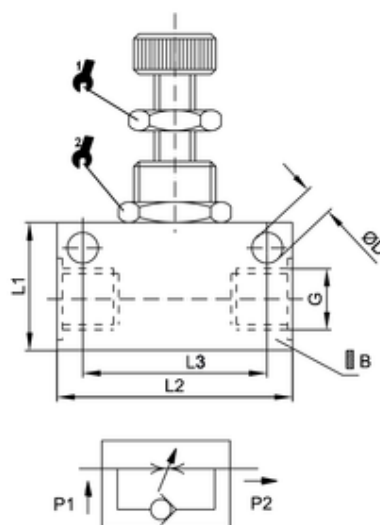

ITV	G	L1	L2	L3	ØD	B	sw1	sw2	NI/min*
304032	G1/4	30	40	24	4,5	20	15	12	300

Körper:	Aluminium
Body:	Aluminium
Corpo:	Alluminio
O-Ring:	NBR
O-ring:	NBR
O-Ring:	NBR 70 SH
zyl. Gewinde:	DIN EN ISO 228
cyl. Threads:	DIN EN ISO 228
Filettatura:	gas cilindrica ISO 228
Betriebstemperatur:	-20 °C bis +80 °C
Working temperature:	-20 °C bis +80 °C
Temperatura di esercizio:	da -20 °C a +80 °C
Betriebsdruck:	max. 10 bar
Working pressure:	max. 10 bar
Pressione di esercizio:	max. 10 bar

Für geölte und ungeölte Druckluft.
For lubricated and non-lubricated compressed air.
Per aria compressa sia lubrificata che non.