



The pedal valves are available with protection or without protection, with or without lock.
Available functions are 3/2 and 5/2.
The large base ensures stability during the use.

La série de valves à pédale est proposée avec ou sans capot de protection avec ou sans fermeture sécurisée, fonction 3/2 et 5/2.
La large base garantit une bonne stabilité durant l'utilisation.

La serie di valvole a pedale, vengono proposte con: protezione o senza protezione, con fermo di sicurezza o senza e nelle funzioni 3/2 e 5/2.
L'ampia base d'appoggio, garantisce stabilità durante l'utilizzo.

TECHNICAL DATA / DONNEES TECHNIQUES / DATI TECNICI

Fluid / Fluide / Fluido	Lubricated or non lubricated air / Air lubrifié ou non / Aria con o senza lubrificazione
Temperature range / Température d'utilisation / Temperatura di esercizio	Max +60C°
Max operating pressure / Pression max d'utilisation / Pressione massima di esercizio	10 bar
Nominal orifice / Diamètre nominal / Diametro nominale	1/4: 7,5mm

COMPONENTS / COMPOSANTS / COMPONENTI

Protection cover / Protection / Protezione	Plastic / Plastique / Plastica /
Body / Corps / Corpo	Aluminium / Aluminium / Alluminio /
Spool / Tiroir / Spola	Nickel plated aluminium / Aluminium niclee / Alluminio nichelato
Seals / Joints / Guarnizioni	NBR
Spring / Ressort / Molla	Steel / Inox / Inox

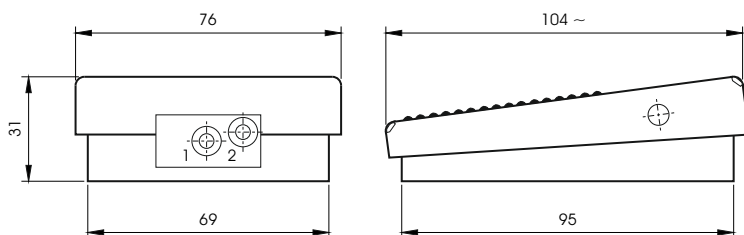

3/2 NC monostable
3/2 NF monostable
3/2 NC monostabile

CODE: VP40200301

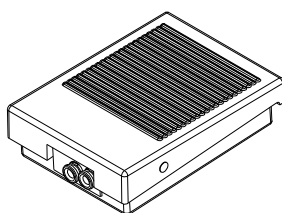
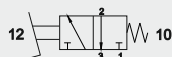

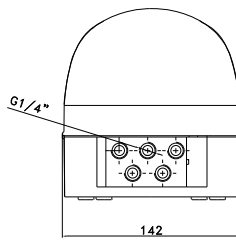
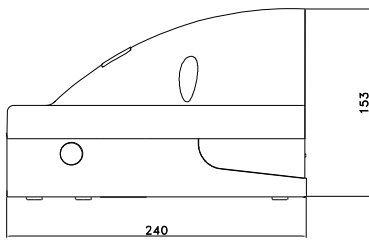

1/4 - 5/2 with protection cover
1/4 - 5/2 avec protection
1/4 - 5/2 con protezione

CODE: VP40010531 mono-stable
monostable
monostabile

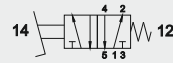

CODE: VP40011531 with safety block
avec fermeture sécurisée
con fermo sicurezza



CODE: VP40010532 bi-stable
bistable
bistabile

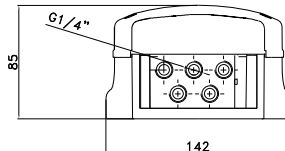
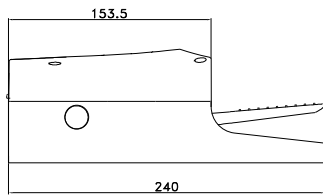
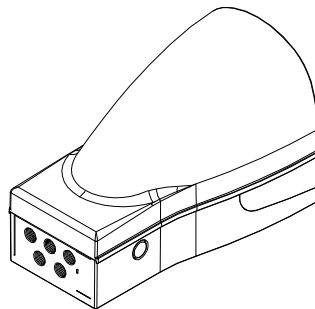
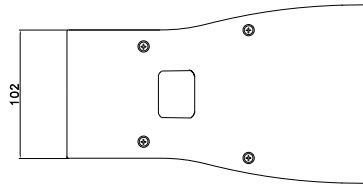

1/4 - 5/2 without protection cover
1/4 - 5/2 sans protection
1/4 - 5/2 senza protezione

CODE: VP40000531 mono-stable
monostable
monostabile

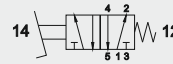

CODE: VP40000532 bi-stable
bistable
bistabile

